

# CYLINDER 3 LVS

## SURFACE MOUNT

PROJECT NAME:	TYPE:
---------------	-------

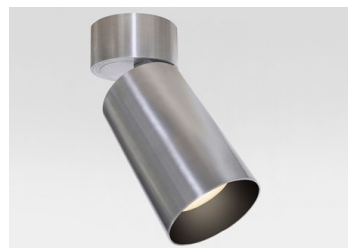

Highlight art, objects, places, spaces, seating areas, and architectural details with a classic profile that offers easy-to-adjust, in-field versatility.

### ORDERING INFORMATION - CYLINDER

Quick Ship Product. All rough in components ship within 10 days up to quantities of 100.

CYLINDER	FIXTURE	RATING	CYLINDER FINISH	BAFFLE FINISH	LUMEN PACKAGE	CCT	OPTIC	DRIVER	EFFECTS DEVICE	MOUNTING
<b>CY3</b>								<b>LVS</b>		
CY3 3.25"	AD Standard 60° 9D Max 90° Tilt* *(Not available for Wet location; Increased lead time)	1 Dry/Damp 2 Wet	WH White BK Black AB Architectural Bronze* *(Increased lead time) AG Satin Silver* *(Increased lead time) MA Machined Aluminum* *(Not available for Fixed Body, 9D, 9S, or Wet Location) CF Custom Finish* *(Consult Factory)	ALL ADJUSTABLE CYLINDERS BK Black CY3-FB ONLY WH White BK Black AB Architectural Bronze* *(Increased lead time) AG Satin Silver* *(Increased lead time) CF Custom Finish* *(Consult Factory)	STATIC WHITE 80C19A 80+ CRI, Delivered Lumens - 1127 80C25A 80+ CRI, Delivered Lumens - 1502 80C32A 80+ CRI, Delivered Lumens - 1961 90C15A 90+ CRI, Delivered Lumens - 905 90C20A 90+ CRI, Delivered Lumens - 1287 90C27A 90+ CRI, Delivered Lumens - 1680 97C14A 97+ CRI, Delivered Lumens - 863 97C19A 97+ CRI, Delivered Lumens - 1151 97C24A 97+ CRI, Delivered Lumens - 1503	22 2200K* *(Only available for 90C15A and 90C20A) 27 2700K 30 3000K 35 3500K 40 4000K	10 10°* *(Only available for 80C19A, 90C15A, and 97C14A. Not available for 2200K) 15 15° 25 25° 40 40° 60 60° WW Wallwash* *(Required and only available for AW fixture)	LVS Low Voltage System	STANDARD EFFECTS DEVICE 4 Soft Focus Lens ALTERNATE EFFECTS DEVICE 0 No Lens* *(Standard for 10° optic. Not available for Warm Dim, or Wet location) 2 Honeycomb Louver* *(Not available for Warm Dim, or Wet location) 3 Clear Glass Lens* *(Not available for Warm Dim) 5 Frosted Glass Lens 6 Frosted Soft Focus Lens 7 Frosted Linear Spread Lens W Wallwash Lens* *(Required and only available for AW fixture)	ROUGH-IN JBMP 4" Sq. or 4/0 Junction Box Mounting Plate FINISH OUT SMK3 3/0 Surface Mount Kit SMK4 4/0 Surface Mount Kit CMJB 1/2" and 3/4" Conduit Ceiling Mount Junction Box* *(Not available for MA finish or Wet location, Quick Ship Product for WH and BK finishes only)
	AS Standard 60° Shallow Canopy* *(Increased lead time)					WARM DIM 90W11A 90+ CRI, Delivered Lumens - 941 Incandescent Profile 90W13A 90+ CRI, Delivered Lumens - 991 Halogen Profile *SEE PAGE 4 FOR DETAILED WARM DIM PROFILE COMPARISON.  *ALL DELIVERED LUMEN OUTPUTS REFLECT 3000K PAIRED WITH 40° OPTIC AND SOFT FOCUS LENS.	WL 2700K-1800K WD 3200K-1800K	25 25° 40 40° 60 60° WW Wallwash* *(Required and only available for AW fixture)		
	9S Max 90° Tilt Shallow Canopy* *(Not available for Wet location; Increased lead time) AW Adjustable Wallwash 60°* *(Not available for Wet location) FB Fixed Body* *(Not available for Wet location)									



### PART NUMBER NOTES



- Adjustable ships as e.g., CY3-AD-1-WH-90C20A2-3-LVS-4
- Fixed Body ships as e.g., CY3-FB1-WHBK-90C27A2-30LVS40
- JBMP ships as CY2/3-JBMP
- SMK3 ships as CY2/3-SMK-3/0-(finish)
- SMK4 ships as CY2/3-SMK-4/0-(finish)
- CMJB ships as CY3-CMJB-(finish)

# CYLINDER 3 LV SURFACE MOUNT

## APPLICATION NOTES

- Lucifer Lighting will not supply a fixture with a POE node or power supply inside the fixture. This allows for easier site install with nodes of 2 or more outputs.
- Consult node manufacturer for maximum remote wiring distances.
- Fixture features 18 Gauge wiring.
- Wiring connections are made on the fixture using customer supplied connectors, ex. wire nuts, push-in connectors, or terminal blocks.
- Confirm node compatibility with factory if it is not listed.
- Customers are responsible for ensuring POE node drive current is set to correct values shown below.
- Customers must ensure voltage range of the proposed POE node encompasses the fixtures complete Vf range, both maximum and minimum. If assistance is required contact LLC rep or factory.

## NODE COMPATIBILITY

Manufacturer	Model Number
 Igor Enabling Smart Buildings™	NP50-60-C-F-5
 molex	180996-1001 180996-1002 180996-2001 180996-2002
 PLATFORMATICS	1 Channel Node, POE-LN2-1U-E 2 Channel Node, POE-LN2-2U-E 4 Channel Node, POE-LN2-4U-E

## DRIVE CURRENT SPECIFICS

	80C			90C			97C			90W	
	19A	25A	32A	15A	20A	27A	14A	19A	24A	11A	13A
Minimum Vf	30.5	30.5	30.5	30.5	30.5	30.5	30.5	30.5	30.5	30.5	30.5
Maximum Vf	39	39	39	39	39	39	39	39	39	39	39
Current mA	400	550	750	400	550	750	400	550	750	400	400
Wattage W	13.6	19.4	27.4	13.6	19.4	27.4	13.6	19.4	27.4	13.6	13.6

	10 DEGREE OPTIC		
	80C19A	90C15A	97C14A
Minimum Vf	30.5	30.5	30.5
Maximum Vf	39	39	39
Current mA	400	400	400
Wattage W	13.6	13.6	13.6

## WIRING DIAGRAM

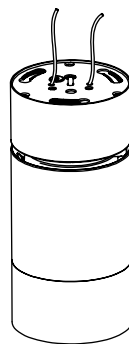

LV CONSTANT  
CURRENT SOURCE:

POE NODE OR  
REMOTE DRIVER

Class 2  
Wiring

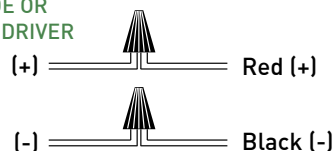

CYLINDER

# CYLINDER 3 LVS SURFACE MOUNT

## ACCESSORIES

### ADJUSTABLE ALTERNATE EFFECTS DEVICES

**HCL-CY3-03** Honeycomb Louver \*

\*(Not available for Warm Dim, or Wet location)

**CGL-CY3-03** Clear Glass Lens \*

\*(Not available for Warm Dim)

**SFL-CY3-03** Soft Focus Lens

**FGL-CY3-03** Frosted Glass Lens

**FSFL-CY3-03** Frosted Soft Focus Lens

**FLSL-CY3-03** Frosted Linear Spread Lens

### FIXED BODY ALTERNATE BAFFLE AND EFFECTS DEVICE

Includes baffle with sealed lens. Must specify baffle finish.

**RBA-CY3-\*\*-HCL** Honeycomb Louver \*

\*(Not available for Warm Dim)

**RBA-CY3-\*\*-CGL** Clear Glass Lens \*

\*(Not available for Warm Dim)

**RBA-CY3-\*\*-SFL** Soft Focus Lens

**RBA-CY3-\*\*-FGL** Frosted Glass Lens

**RBA-CY3-\*\*-FSFL** Frosted Soft Focus Lens

**RBA-CY3-\*\*-FLSL** Frosted Linear Spread Lens

\*\* Baffle finish: Specify **WH** for white, **BK** for black, **AG** for satin silver or **AB** for architectural bronze.

### REPLACEMENT OPTICS

Interchangeable optics accessible by removing snoot or baffle. Not available for Wallwash fixtures.

**RO-70-15-1** 15° optic \*

\*(Not available for Warm Dim)

**RO-70-25-1** 25° optic

**RO-70-40-1** 40° optic

**RO-70-60-1** 60° optic

### FIXED BODY REPLACEMENT SUCTION TOOL

Included with each CY3-FB order (1 per 10 fixtures).

**CY-SQ-TOOL-SUCTION** Baffle assembly removal tool

# CYLINDER 3 LVS SURFACE MOUNT

## STATIC WHITE PERFORMANCE - 3000K

LUMEN PACKAGE	WATTAGE	10° OPTIC NO SOFT FOCUS LENS		15° OPTIC SOFT FOCUS LENS		20° OPTIC SOFT FOCUS LENS		40° OPTIC SOFT FOCUS LENS		60° OPTIC SOFT FOCUS LENS		WW OPTIC WALLWASH LENS	
		DELIVERED	LPW	DELIVERED	LPW	DELIVERED	LPW	DELIVERED	LPW	DELIVERED	LPW	DELIVERED	LPW
80C19A	17	1040	60	1352	80	1314	77	1127	66	1202	71	863	51
80C25A	24	-	-	1802	76	1752	73	1502	63	1602	67	1151	48
80C32A	33	-	-	2353	71	2288	69	1961	59	2092	63	1503	46
90C15A	17	882	51	1158	68	1127	66	905	53	1030	61	740	44
90C20A	24	-	-	1544	65	1502	63	1287	54	1373	58	987	41
90C27A	33	-	-	2016	61	1960	59	1680	51	1792	54	1288	39
97C14A	17	731	43	1037	61	1007	59	863	51	921	54	662	39
97C19A	24	-	-	1382	58	1343	56	1151	48	1228	51	883	37
97C24A	33	-	-	1804	55	1754	53	1503	46	1603	49	1152	35
90W11A	16	-	-	-	-	994	62	941	59	986	62	613	38
90W13A	16	-	-	-	-	1046	65	991	62	1038	65	645	40

OUTPUT MULTIPLIER	
CCT	CCT SCALE
2200K	0.800
2700K	0.957
3000K	1.000
3500K	1.019
4000K	1.030

LIGHT LOSS FACTOR MULTIPLIER	
No Lens	1.05
CGL	1.05
SFL	1.00
FGL	0.90
FSFL	0.87
FLSL	0.83
HCL	0.65

## WARM DIM PERFORMANCE - SOFT FOCUS LENS - 40° OPTIC

WARM DIM TO MIRROR HALOGEN DIMMING PROFILE

90W13A 3200K - 1800K	Full on 100%	Dimmed to 80%	Dimmed to 70%	Dimmed to 50%	Dimmed to 20%	Dimmed to 10%	Dimmed to 2%
CCT (K)	3200	3150	3100	3000	2700	2200	1800
Light Output (Lm)	991	793	694	495	198	99	20
Power (W)	16	13	11	8	3	1.7	0.3
Efficacy (LPW)	62	62	62	62	62	62	62

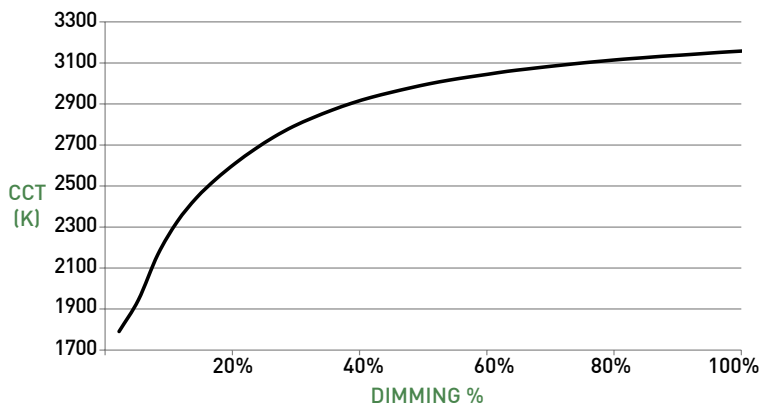

WARM DIM TO MIRROR INCANDESCENT DIMMING PROFILE

90W11A 2700K - 1800K	Full on 100%	Dimmed to 80%	Dimmed to 70%	Dimmed to 50%	Dimmed to 20%	Dimmed to 10%	Dimmed to 2%
CCT (K)	2700	2650	2620	2520	2180	1950	1800
Light Output (Lm)	941	753	659	470	188	94	20
Power (W)	16	13	11	8	3	1.7	0.3
Efficacy (LPW)	59	59	59	59	59	59	59

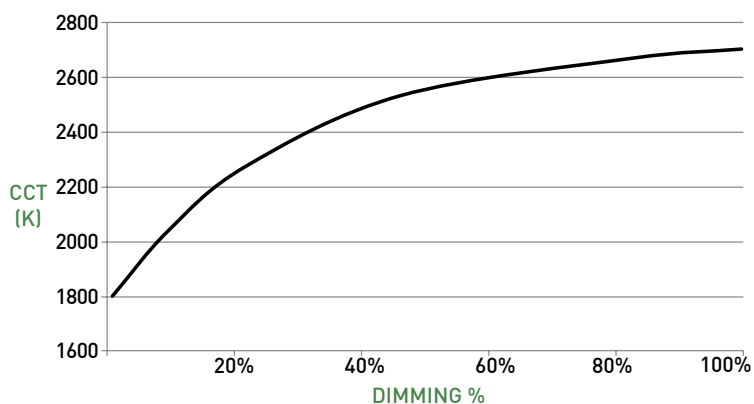

# CYLINDER 3 LVS SURFACE MOUNT

## STEM ASSEMBLY

- A LUMINAIRE**  
Body with integrated heat sink and LED. Conceals hidden twist-on mounting hardware. Power supply must remote mount.
- B STANDARD CANOPY**  
Die-cast canopy accommodates flat and slope ceiling conditions. Conceals hidden twist-on mounting hardware. "AD" (60° tilt, 357° rotation) and "9D" (90° tilt, 357° rotation) canopy features 1.80" (46mm) tall canopy.
- C SHALLOW CANOPY**  
Die-cast canopy accommodates flat and slope ceiling conditions. Conceals hidden twist-on mounting hardware. "AS" (60° tilt, 357° rotation) and "9S" (90° tilt, 357° rotation) canopy features 0.50" (13mm) tall canopy, reducing overall height.
- D STANDARD OPTICS**  
Proprietary optics available in 10°, 15°, 25°, 40° & 60° beams.
- WALLWASH OPTIC**  
Precision tuned kick reflector and optic provides uniform wallwashing effect.
- E ADJUSTABLE EFFECTS DEVICE**  
Threaded removable cowling provides virtually seamless joint with fixture body and accepts 1 lens; soft focus lens standard. Sealed in place for Wet locations. Wallwash fixture is fitted with a wallwash lens.
- FIXED BODY EFFECTS DEVICE**  
Cylinder baffle assembly can accept 1 lens; soft focus lens standard and sealed in place. Suction tool provided for removal of baffle lens assembly.
- F WALL-MOUNT**  
CY3-AD / 9D / AS / 9S may be wall mounted using any mounting option, Dry / Damp location only.

## DIMENSIONS / DRAWINGS

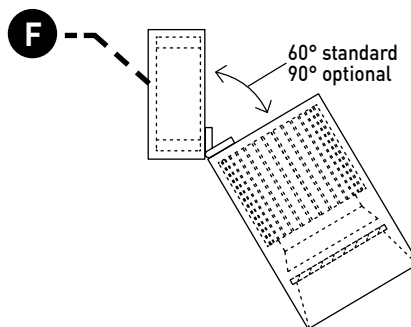
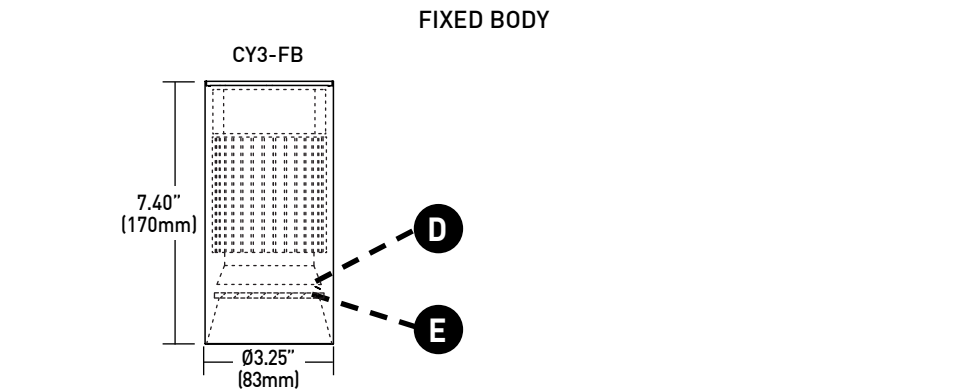
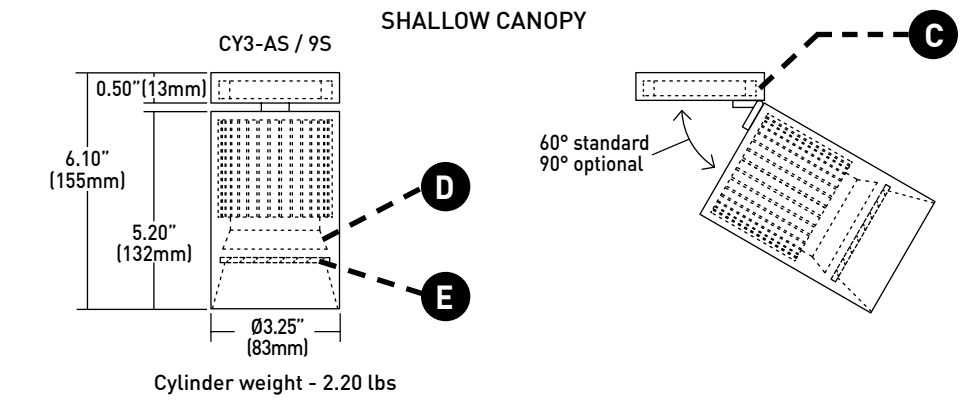
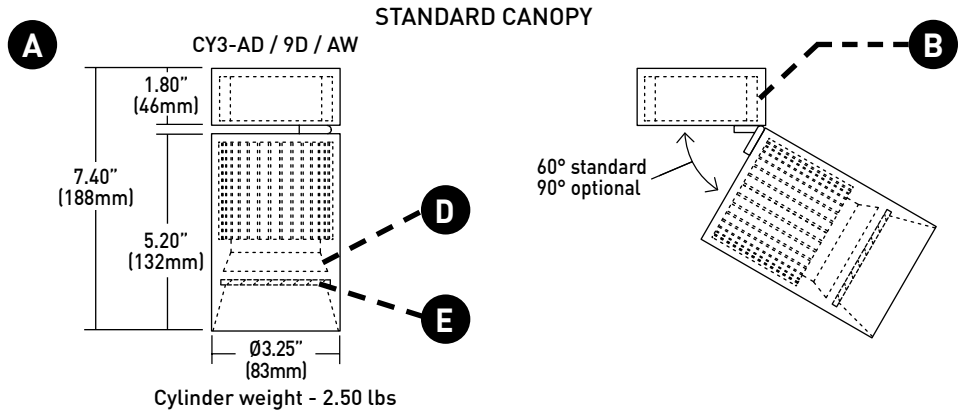

# CYLINDER 3 LVS SURFACE MOUNT

## MOUNTING

- G JBMP**  
Mounting plate (concealed) for standard 4" square or 4" 4/0 j-box . To be installed during rough-in prior to substrate. Fixture to mount flush with minimalist transition to ceiling.
- H SMK3**  
Surface mount kit includes mounting plate and 4" concealer plate that installs between fixture and standard 3" 3/0 j-box for existing applications where standard j-box cutout is to be concealed.
- I SMK4**  
Surface mount kit includes mounting plate and 5" concealer plate that installs between fixture and standard 4" 4/0 j-box for existing applications where standard j-box cutout is to be concealed.
- J CMJB**  
Ceiling mount junction box perfectly matches the cylinder profile for a continuous, integrated look where exposed ceiling mount junction box and conduit applications apply. For use with 1/2" and 3/4" EMT conduit only. Features two conduit entrances on either side and one conduit knockout on top of j-box. J-box is IP10 rated; painted finishes only. Blank off plugs included.

## DIMENSIONS / DRAWINGS

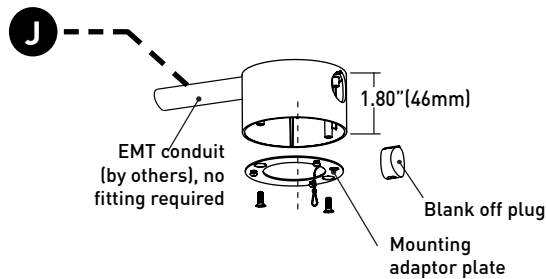
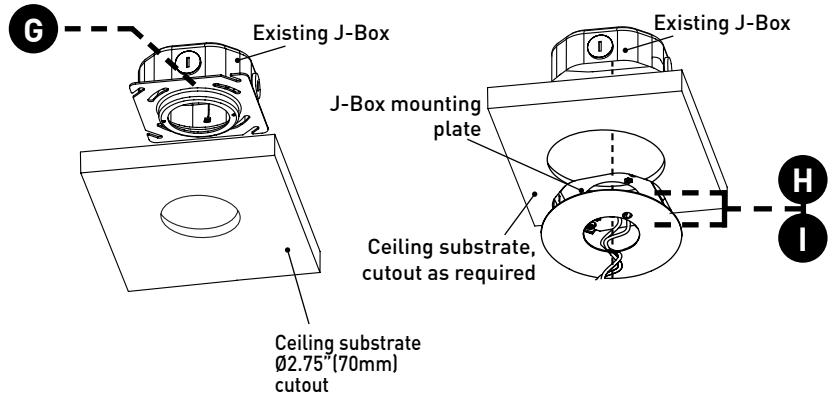

## MOUNTING NOTES

- CY2/3-JBMP and CY2/3-SMK-3/0 & 4/0 not recommended for use with pancake style j-box.

# CYLINDER 3 LVS SURFACE MOUNT

## TECHNICAL

### CONSTRUCTION

**Cylinder:** Die-cast or Machined aluminum body; extruded aluminum internal heat-sink; painted finishes are granulated powder coat.

**CMJB:** Die-cast aluminum body; painted finishes are granulated powder coat.

### STATIC WHITE LED

2-step MacAdam ellipse LED module available in 80+, 90+ and 97+ CRI configurations in color temperatures of 2200K, 2700K, 3000K, 3500K and 4000K. Average rated lamp life of 50,000 hours. LED and driver assemblies are field-replaceable.

### WARM DIM LED

3-step MacAdam ellipse warm dim LED module available in 90+ CRI configuration. 3200K or 2700K at full brightness, warming to 1800K at full dim. Average rated lamp life of 50,000 hours. LED and driver assemblies are field-replaceable.

### WALLWASH SPACING AND TILT

Cylinder must be tilted to achieve wallwashing effect. Recommended fixture spacing is 36" (914mm) on center with 36" (914mm) setback from wall plane with 30° tilt.

### MOUNTING

Cylinder is supplied with a mounting adaptor plate, which integrates with required additional mounting accessories specified separately according to field application conditions, providing a minimalist transition from standard 4/0 or 4" square junction boxes and accommodating ceiling thicknesses of 0.44" (12mm) to 0.75" (19mm). Ceiling-mount junction box available for 1/2" (13mm) and 3/4" (19mm) conduit and feature concealed internal clamps for clean fitting-free conduit exit and entry.

### LISTING

cTUVus listed to UL2108 standard for Dry / Damp and Wet locations.

### WARRANTY

Manufacturer's 1-year warranty guarantees product(s) listed to be free from defects in material and workmanship under normal use and service. 5-year warranty on LED to operate with 70% of the original flux and remain within a range of 3 duv. Warranty period begins from the date of shipment by Seller. [Consult website for full warranty terms and conditions.](#)

### CHANGE LOG

1. 01/12/2021: ADDED 2200K, 2700K-1800K WARM DIM AND 10 DEGREE OPTIC OFFERINGS.