

FRAXION3SLIM ADJUSTABLE

ACCESSORIES

ROUND ALTERNATE EFFECTS DEVICES

Dry/Damp location only.
Wet location requires alternate baffle.

- CGL-F3R** Clear Glass Lens*
*(Not available for Warm Dim)
- FGL-F3R** Frosted Glass Lens
- SFL-F3R** Soft Focus Lens
- FSFL-F3R** Frosted Soft Focus Lens
- WDL-F3R** Wide Distribution Lens*
*(Required and only available for 85° beam spread)
- FLSL-F3R** Frosted Linear Spread Lens

SQUARE ALTERNATE EFFECTS DEVICES

Dry / Damp location only.
Wet location requires alternate baffle.

- CGL-F3S** Clear Glass Lens*
*(Not available for Warm Dim)
- FGL-F3S** Frosted Glass Lens
- SFL-F3S** Soft Focus Lens
- FSFL-F3S** Frosted Soft Focus Lens
- WDL-F3S** Wide Distribution Lens*
*(Required and only available for 85° beam spread)
- FLSL-F3S** Frosted Linear Spread Lens

ADJUSTABLE HCL ASSEMBLY

Dry / Damp location only.

- OLR-F3RS1-SFL-HCL** Adjustable Honeycomb Louver and Soft Focus Lens

ALTERNATE BAFFLE ASSEMBLY (INCLUDES EFFECTS DEVICE)

ASSEMBLY	SHAPE	TRIM	RATING	FLANGE FINISH	EFFECTS DEVICE
RBA				1	
REPLACEMENT BAFFLE ASSEMBLY	F3R Round F3S Square	MAS Microflange TAS Trimless MAT Microflange Transitional Baffle TAT Trimless Transitional Baffle	1 Dry / Damp 2 Wet* *(Requires suction cup to service or aim & focus)	WH White BK Black PR Primer AU Cashmere Gold AG Satin Silver BB Burnt Bronze CF Custom Finish * *(Consult Factory)	Leave blank for standard Soft Focus Lens CGL Clear Glass Lens * *(Not available for Warm Dim) FGL Frosted Glass Lens FSFL Frosted Soft Focus Lens WDL Wide Distribution Lens * *(For use with 60° optic only) FLSL Frosted Linear Spread Lens

REPLACEMENT OPTICS

Interchangeable optics accessible through fixture aperture.

- RO-50-15-2** 15° optic
- RO-50-22-2** 22° optic
- RO-50-40-2** 40° optic
- RO-50-60-2** 60° optic

REPLACEMENT SUCTION TOOL

One included with every six fixtures designated Wet location.

- F4-TOOL-SUCTION** Allows for removal of Wet Location baffles

EMERGENCY LIGHTING - REMOTE MOUNT ONLY

During disruption of main power, emergency battery inverter provides temporary 120V or 277V to fixture.

- EMB-S-20/25-120/277-LEDX** 20/25 watt max capacity, 120 or 277 VAC 60Hz, Non-Dimmable
- EMB-S-100-120-LEDX** 100 watt max capacity, 120 VAC 60Hz, Dimmable
- EMB-S-100-277-LEDX** 100 watt max capacity, 277 VAC 60Hz, Dimmable
- EMB-S-250-120/277-LEDX** 250 watt max capacity, 120 or 277 VAC 60Hz, Dimmable

FRAXION3SLIM ADJUSTABLE

PERFORMANCE - 3000K - SOFT FOCUS LENS

LUMEN PACKAGE	WATTAGE	15° OPTIC		22° OPTIC		40° OPTIC		60° OPTIC		85° BEAM	
		DELIVERED	LPW	DELIVERED	LPW	DELIVERED	LPW	DELIVERED	LPW	DELIVERED	LPW
80C12A	10	872	86	729	72	795	79	784	78	623	62
80C16A	14	1191	82	1003	71	1095	78	1079	77	857	61
80C23A	21	1642	77	1381	65	1506	71	1486	70	1180	56
90C10A	10	721	71	626	62	683	68	673	67	535	53
90C14A	14	984	68	858	61	936	66	923	65	733	52
90C19A	21	1357	63	1184	56	1291	61	1273	60	1011	48
97C10A	10	657	65	557	55	608	60	599	59	476	47
97C12A	14	897	62	763	54	833	59	821	58	652	46
97C17A	21	1238	58	1055	50	1151	58	1135	54	901	42
90W13A	16	-	-	726	45	902	50	857	53	757	47

OUTPUT MULTIPLIER			
CCT	80+ CRI	90+ CRI	97+ CRI
2700K	1.158	0.957	0.873
3000K	1.211	1.000	0.912
3500K	1.234	1.019	0.927
4000K	1.249	1.030	0.940

LIGHT LOSS FACTOR MULTIPLIER	
CGL	1.05
SFL	1.00
FGL	0.90
FSFL	0.87
FLSL	0.83
WDL	0.78

WARM DIM PERFORMANCE

DETAILED PERFORMANCE	Full on 100%	Dimmed to 80%	Dimmed to 70%	Dimmed to 50%	Dimmed to 20%	Dimmed to 10%	Dimmed to 2%
CCT (K)	3200	3150	3100	3000	2700	2200	1800
Light Output (Lm)	1300	1050	900	630	250	115	25
Power (W)	14	11	10	7	3	1.5	0.3
Efficacy (LPW)	92	93	90	90	83	76	74

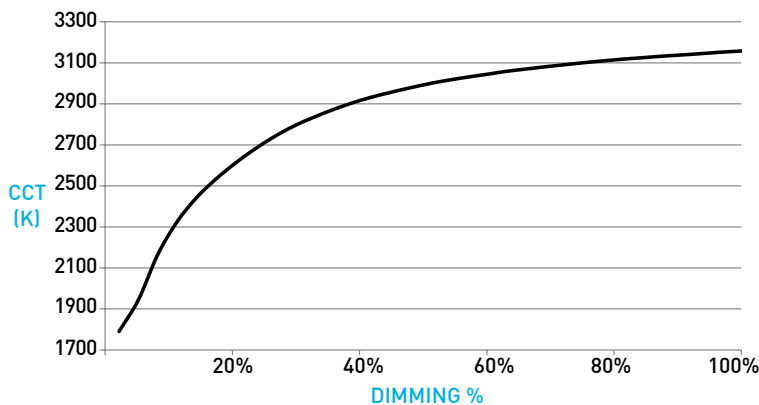

FRAXION3SLIM ADJUSTABLE

DOWNLIGHT / HOUSING

A ADJUSTABILITY

Aiming mechanism is integral to the housing, providing hot-aim tilt up to 40° and 365° rotation. Sliding pivot point optimizes center beam, ensuring unclipped beam of 15° at 40° tilt and 25° at 30° tilt. 1° tilt increments with 5° indicators, tilt guide included (see **A1** section view).

B LED

Integral LED module design enables field service / replacement through housing aperture.

C OPTIC

Proprietary field-changeable optic integrates Reflection, Refraction and TIR offering 15°, 22°, 40° & 60° beams.

D1 MICROFLANGE PROFILE

Features 0.30" flange. Thickness measures 0.06". Installed after ceiling is complete. Requires 3.375" diameter cutout. Wet location features integral silicone gasket.

D2 TRIMLESS PROFILE

Installs totally flush with the ceiling with no visible trim. Appliqué includes screws for mounting and has 0.06" plaster stop. Not recommended for stucco applications.

E EFFECTS DEVICES / LENS RETAINER

Soft focus lens included and sealed in Wet locations. Fixture is limited to 1 effects device. Suction tool provided for removal of baffle with wet location. Lens retainer allows effects devices to be changed in Dry /Damp locations.

E1 ADJUSTABLE HCL ASSEMBLY

Honeycomb Louver and Soft Focus Lens attach directly to optic with clip-on lens retainer and adjusts with fixture. Only compatible with no lens baffle. Dry/Damp locations only.

F ROUND BAFFLE

Die-cast removable baffle provides easy access to tilting mechanism and features 62° glare cutoff. Minimizes aperture glare and conceals view into housing; includes silicone gasket.

TRANSITIONAL BAFFLE

Die-cast removable baffle provides easy access to tilting mechanism and features 62° glare cutoff. Transitions from square aperture at ceiling plane to round aperture at light source. Minimizes aperture glare and conceals view into housing; includes silicone gasket.

DIMENSIONS / DRAWINGS

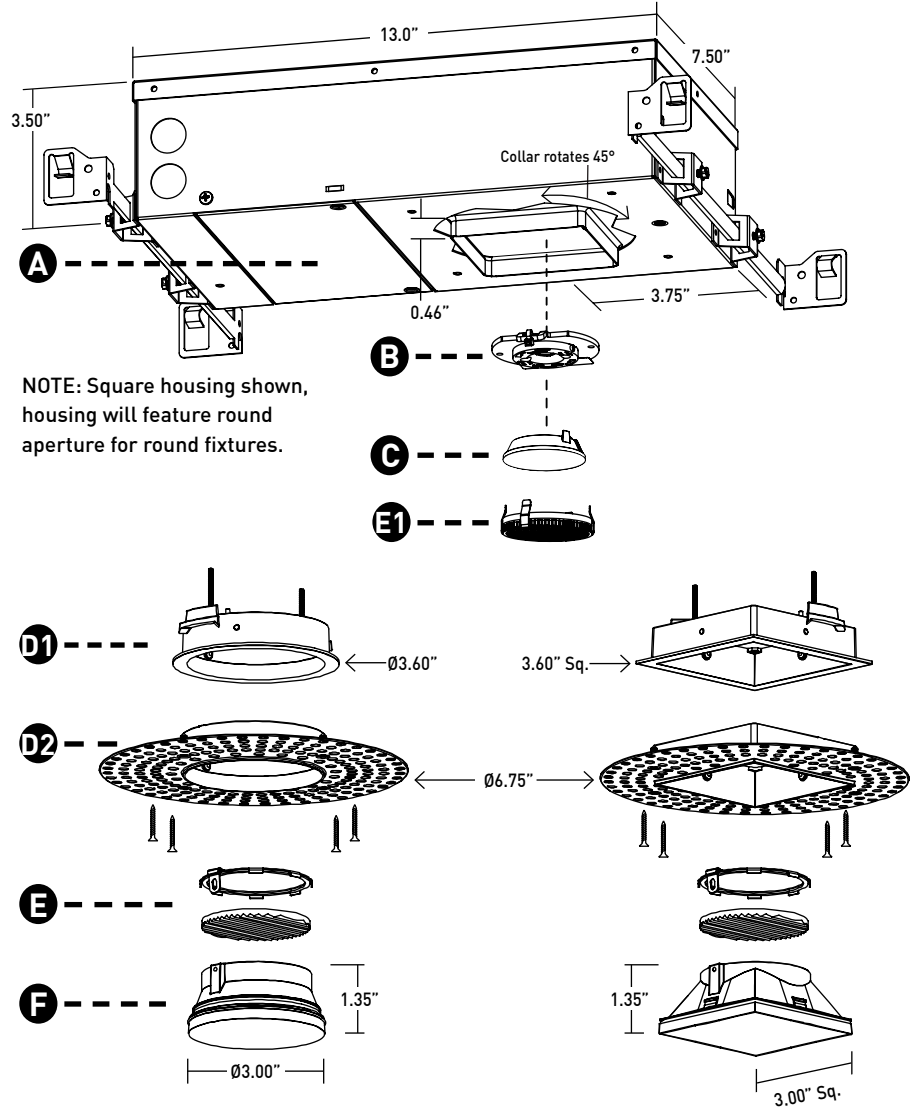

A1

SECTION VIEW

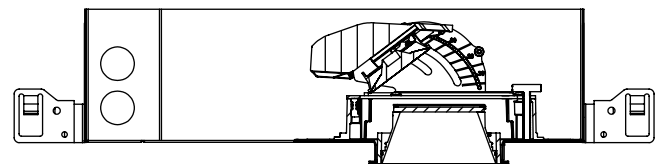

FRAXION3SLIM ADJUSTABLE

DOWNLIGHT / HOUSING

- G APPLIQUÉ DETAIL**
Appliqué for plaster floating directly to baffle.
- H ADJUSTABLE HANGER BAR HEIGHT ACCESSORY**
Provided with ceiling thickness "T" and recommended for installations in T-Grid and with furring channel. Hanger bars are installed to adjustable bracket. Allows housing to be raised and lowered; ceiling thickness remains 0.5" to 1.0" max.
- I IC HOUSING**
- For IC ceilings.
 - Chicago Plenum, Airtight and Title 24 (JA8) listed.
 - No setback from polycell spray foam insulation having max R-Value of 60 on all sides and top of housing.
- J NIC HOUSING**
- Minimum 0.50" setback from combustible and non-combustible materials on all sides and top of housing.
 - Minimum 3.00" setback from insulation material having max R-Value 30 on all sides and top of housing.
 - Minimum 6.00" setback from polycell spray foam insulation having max R-Value 60.
- K REMOTE POWER SUPPLY**
Provided with install Types "V", "W" and "D". Remote power supply provides additional driver options. Consult installation guide for maximum allowable secondary run lengths between PSF3-RMT and fixture. Must be installed in an accessible location.

HOUSING NOTES

- Do not install in environments where ambient temperatures exceed 40°C (104°F).
- Power supply compartment and all splice connections may be serviced from room side.
- Consult factory for spacing requirements for any installations exceeding R-Value 60.
- Hanger bars fitted to short side of housing, extend from 14.0" to 24.0", but may be field cut to accommodate narrow stud spacing.
- Hanger bars and brackets add 4.00" to the overall dimension, but are exclusive of the setback requirements.
- Housings for round trims feature a round aperture housing collar, and for square trims, a square housing collar, accommodating ceiling thicknesses between 0.50" and 1.00".

G

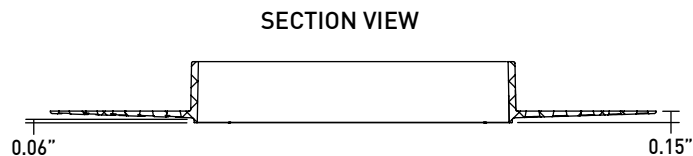

H

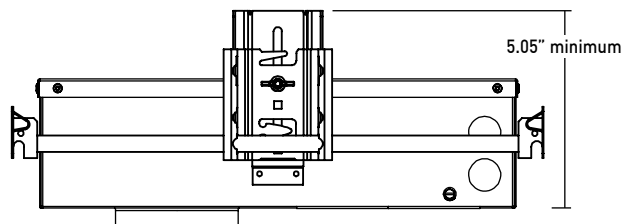

I / J

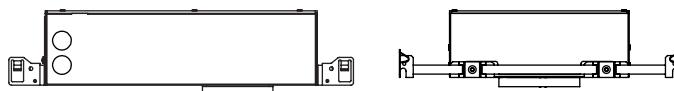

IC HOUSING FEATURES STRIP GASKETS

K

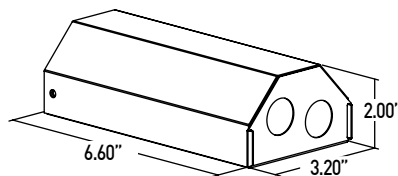

FRAXION3SLIM ADJUSTABLE

TECHNICAL

CONSTRUCTION

Downlight: Painted finishes are granulated powder coat.

Housing: Aluminum and 22 Gauge galvanized steel. Extruded aluminum housing panel to act as heat-sink.

Remote Power Supply: 22 Gauge galvanized steel.

Appliqué: Zinc alloy.

LED

Proprietary Citizen 2-step MacAdam ellipse LED module available in 80+, 90+ and 97+ CRI configurations in color temperatures of 2700K, 3000K, 3500K and 4000K. Average rated lamp life of 50,000 hours. LED and driver assemblies are field-replaceable.

WARM DIM LED

Proprietary 3-step MacAdam ellipse warm dim LED module available in 90+ CRI configuration. 3200K at full brightness, warming to 1800K at full dim. Average rated lamp life of 50,000 hours. LED and driver assemblies are field-replaceable.

POWER SUPPLY PERFORMANCE AND DIMMING INFORMATION

Power Supply	RP1	RN1	TR2	LH1	L23	EA2	LA2	ED1	LD1
Minimum °C	-10 °C	-10 °C	-20 °C	0 °C	0 °C	-20 °C	-20 °C	-20 °C	-20 °C
Maximum °C	40 °C	40 °C	40 °C	40 °C	40 °C	40 °C	40 °C	40 °C	40 °C
Dimming %	1.0%	1.0%	2.0%	1.0%	1.0%	0.1%	0.1%	0.1%	0.1%

Note: For TR2, L23, LH1, LP1, EA2 and LA2 drivers consult chart on page 7 to confirm appropriate dimming curve for compatibility with selected control.

LISTING

cTUVus listed to UL1598 standard for Dry / Damp and Wet locations.

Chicago Plenum, Airtight and Title 24 JA8-2019 Listed.

U.S. Patent: 10,317,066

WARRANTY

Manufacturer's 1-year warranty guarantees product(s) listed to be free from defects in material and workmanship under normal use and service. 5-year warranty on LED and power supply to operate with 70% of the original flux and remain within a range of 3 duv. 10-year Lutron Advantage limited warranty available on Lutron equipped systems. Warranty period begins from the date of shipment by Seller and conditional upon the use of manufacturer-supplied power supply. [Consult website for full warranty terms and conditions.](#)

CHANGE LOG

- 04/03/2020: ADDED ADJUSTABLE HCL ASSEMBLY
- 03/09/2020: ADDED TRIMLESS TO FLANGE FINISH OPTIONS
- 02/05/2020: REMOVED AN4, CA2, CE2, AND LN2 DRIVERS AND ADDED RN1 AND RP1 DRIVERS
- 10/08/2019: NEW CONSOLIDATED SPEC SHEET WITH SINGLE NOMENCLATURE FOR SPECIFICATION
- 10/08/2019: ADDITIONAL PHOTOMETRIC INFORMATION NOW AVAILABLE ON SPEC SHEET

FRAXION3SLIM ADJUSTABLE

DIMMING COMPATIBILITY

PHILIPS DRIVER COMPATIBILITY

Power supply TR2 Manufacturer	Family/Model #
Lutron Electronics	DV-600P
Lutron Electronics	DVELV-303P
Lutron Electronics	NTELV-600
Lutron Electronics	MAELV-600
Lutron Electronics	SELV-300P
Lutron Electronics	DVLV-600P
Lutron Electronics	NFTU-5A
Lutron Electronics	CTCL-153P
Lutron Electronics	GL-600H
Lutron Electronics	S-600P
Lutron Electronics	PHPM

LUTRON DRIVER COMPATIBILITY

Power supply L23 Lutron Product Family	Part No.
Maestro WirelessR 600 W dimmer	MRF2-6ND-120-
Maestro WirelessR 1000 W dimmer	MRF2-10ND-120-
Caséta® Wireless Pro 1000 W dimmer	PD-10NXD-
GRAFIK T™ CL® dimmer	GT-250M-GTJ-250M-
HomeWorks® QS adaptive dimmer	HQRD-6NA-
HomeWorks® QS 600 W dimmer	HQRD-6ND-
HomeWorks® QS 1000 W dimmer	HQRD-10ND-
RadioRA® 2 adaptive dimmer	RRD-6NA-
RadioRA® 2 1000 W dimmer	RRD-10ND
myRoom™ DIN power module	MQSE-4A1-D
HomeWorks® QS DIN power module	LQSE-4A1-D
HomeWorks® QS wallbox power module	HQRJ-WPM-6D-120
HomeWorks® wallbox power module	HWI-WPM-6D-120
GRAFIK Eye® QS control unit	QSGR-, QSGRJ-
GRAFIK Eye® 3000 control unit	GRX-3100-GRX-3500-
RPM-4U module (LCP, HomeWorks® QS, GRAFIK Systems™, Quantum®)	HW-RPM-4U-120 LP-RPM-4U-120
RPM-4A module (LCP, HomeWorks® QS, GRAFIK Systems™, Quantum®)	HW-RPM-4A-120, LP-RPM-4A-120
GP dimming panels	Various
Ariadni CL 250W dimmer	AYCL-253P-
Diva CL 250W dimmer	DVCL-253P-DCSCCL-253P-
Nova T CL 250W dimmer	NTCL-250-
Power supply LH1 / LP1 Lutron Product Family	Part No.
PowPak Dimming Modules	RMJ-ECO32-DV-B
PowPak Dimming Modules	FCJ/FCJS-ECO
Energi Savr Nodes	QSN-1ECO-S
GRAFIK Eye QS control unit	QSN-2ECO-S
Homeworks QS control unit	QSGRJ- _E (wireless) QSGR- _E
Quantum Hub	QP2-__ 2C
Quantum Hub	QP2-__ 4C
Quantum Hub	QP2-__ 6C
Quantum Hub	QP2-__ 8C
Homeworks QS power module	LQSE-2ECO-D
myRoom Plus power module	

eldoLED DRIVER COMPATIBILITY

Power supply EA2 / LA2 Dimmer / Switch Control Manufacturer	Family/Model #
Busch-Jaeger	2112U-101
Jung	240-10
Leviton Lighting Controls	IP710-DLX
Lightolier Controls	ZP600FAM120
Lutron Electronics	Nova T® - NTFTV
Lutron Electronics	Divia® - DDTV
Lutron Electronics	Nova® - NFTV
Merten	5729
Pass & Seymour	CD4FB-W
The Watt Stopper	DCLV1
Sensor Switch	nI0 EZ
Synergy	ISD BC
Power supply EA2 / LA2 Lighting Control System Manufacturer	Family/Model #
Lutron Electronics	GrafixEye® GRX-TVI w GRX3503
Lutron Electronics	Energy Savr Node™ - QSN-4T16-S
Lutron Electronics	TVM2 Module
Crestron®	GLX-DIMFLV8
Crestron®	GLXP-DIMFLV8
Crestron®	GLPAC-DIMFLV4-*
Crestron®	GLPAC-DIMFLV8-*
Crestron®	GLPP-DIMFLVEX-PM
Crestron®	GLPP-1DIMFLV2EX-PM
Crestron®	GLPP-1DIMFLV3EX-PM
Crestron®	DIN-A08
Crestron®	DIN-4DIMFLV4
Crestron®	CLS-EXP-DIMFLV
Crestron®	CLCI-1DIMFLV2EX
ABB	SD/S 2.16.1



FRAXION3SLIM ADJUSTABLE

DRIVE CURRENT SPECIFICS

	80C			90C			97C			90W
	12A	16A	23A	10A	14A	19A	10A	12A	17A	13A
Minimum Vf	30.5	30.5	30.5	30.5	30.5	30.5	30.5	30.5	30.5	30.5
Maximum Vf	39	39	39	39	39	39	39	39	39	39
Current mA	250	350	500	250	350	500	250	350	500	14 - 350
Wattage W	8.2	11.8	17.4	8.2	11.8	17.4	8.2	11.8	17.4	14