

# FRAXION® 3 SLIM

## WALLWASH

Lots of light in an under-the-radar profile, with multiple design and installation options, ideal for corporate offices and retail settings.

PROJECT NAME:	TYPE:
---------------	-------



### ORDERING INFORMATION - DOWNLIGHT / HOUSING

Quick Ship Product. All rough in components ship within 10 days up to quantities of 100.

**T24** JA8-2019 INDICATED BY SHADING

SHAPE	TRIM	RATING	TYPE	FLANGE FINISH	BAFFLE FINISH	LUMEN PACKAGE	CCT	OPTIC	INSTALL TYPE	CEILING THICKNESS	DRIVER
			<b>W</b>					<b>WW</b>			
F3R Round	M Microflange	1 Dry/Damp	W Wallwash	WH White	WH White	<b>STATIC WHITE</b>	22 2200K*	WW Wallwash	<b>INTEGRAL DRIVER</b>	1 0.50" - 1.375"	<b>INTEGRAL</b>
F3S Square	T Trimless Drywall	2 Wet*		BK Black	BK Black	80C12A 80+ CRI	*[Only available with 90C10A and 90C14A]		X IC	2 1.375" - 2.125"	PH ELV/Triac, 2% 120V*
	W Trimless Wood*	*[Requires provided suction cup to service or aim & focus]		PR Primer	PR Primer	Dvld. Lumens - 679			Y NIC	T 0.50" - 1.375"	* [Not available for 80C12A, 90C10A, and 97C10A]
				AU Cashmere Gold	AU Cashmere Gold	80C16A 80+ CRI	27 2700K		C IC, Airtight	* [Includes adjustable housing height bracket, recommended for any T-Grid or Furring Channel applications]	SG 0-10V Analog, LOG 1% 120 or 277V
				AG Satin Silver	AG Satin Silver	Dvld. Lumens - 934			* [Chicago Plenum, Airtight & Title 24 compliant housing]		SN 0-10V Analog, LIN 1% 120 or 277V
				BB Burnt Bronze	BB Burnt Bronze	80C23A 80+ CRI	30 3000K		<b>REMOTE DRIVER</b>		LP Lutron, Hi-Lume Premier Ecosystem 0.1% Fade to Black, 120 or 277V*
				OO Trimless*	CF Custom Finish*	Dvld. Lumens - 1286	35 3500K		V IC, Remote		* [Not available for 80C23A, 90C19A, or 97C17A in all IC install types]
				CF Custom Finish*	CF Custom Finish*	90C10A 90+ CRI	40 4000K		W NIC, Remote		<b>REMOTE (120V)</b>
						90C14A 90+ CRI			D IC, Airtight, Remote*		L2 Lutron, Hi-Lume 1% 2-wire
						Dvld. Lumens - 583			* [Chicago Plenum, Airtight & Title 24 compliant housing]		<b>REMOTE (120-277V)</b>
						90C19A 90+ CRI					EG eldoLED, SOLOdrive 0.1% 0-10V, LOG
						Dvld. Lumens - 799					EN eldoLED, SOLOdrive 0.1% 0-10V, LIN
						97C10A 97+ CRI					ED eldoLED, SOLOdrive 0.1% DALI, LOG
						Dvld. Lumens - 519					
						97C12A 97+ CRI					
						Dvld. Lumens - 711					
						97C17A 97+ CRI					
						Dvld. Lumens - 982*					
						* [Not available for IC housings]					
						<b>WARM DIM</b>					
						90W11A 90+ CRI	WL 2700K - 1800K				
						Dvld. Lumens - 719					
						Incandescent Profile					
						90W13A 90+ CRI	WD 3200K - 1800K				
						Dvld. Lumens - 757					
						Halogen Profile					
						*SEE PAGE 3 FOR DETAILED WARM DIM PROFILE COMPARISON.					
						<b>TUNABLE WHITE</b>					
						90T12A 90+ CRI	TW 5000K - 2700K				
						Dvld. Lumens - 764*					
						* [Only available for remote housings]					
						*ALL DELIVERED LUMEN OUTPUTS AND T24 COMPLIANCE REFLECT 3000K PAIRED WITH 40° OPTIC AND SOFT FOCUS LENS. REFERENCE PAGE 3 FOR ADDITIONAL T24 COMPLIANT CONFIGURATIONS.					



### PART NUMBER NOTES

- Housing and trim ship as e.g., F3RM1W-WHWH-90C10A2-3X1-PH\*
- Remote driver ships with fixture as e.g., PSF3-RMT-90C-10A-1L2\*

# FRAXION3SLIM WALLWASH

## ACCESSORIES

### REPLACEMENT OPTIC

Interchangeable optics accessible through fixture aperture.

- RO-50-WW-2** Wallwash optic

### REPLACEMENT TUNABLE WHITE OPTIC

Interchangeable optics accessible through fixture aperture.

- RO-50-WW-3** Wallwash optic

### ALTERNATE BAFFLE ASSEMBLY (INCLUDES EFFECTS DEVICE)

ASSEMBLY	SHAPE	RATING	TYPE	BAFFLE FINISH
<b>RBA</b>			<b>W</b>	
REPLACEMENT BAFFLE ASSEMBLY	F3R Round F3S Square	1 Dry / Damp 2 Wet* *(Requires suction cup to service or aim & focus)	W Wallwash	WH White BK Black PR Primer AU Cashmere Gold AG Satin Silver BB Burnt Bronze CF Custom Finish * *(Consult Factory)

### T-GRID ACCESSORY KIT

Supplied with ceiling thickness "T" and recommended for installations in T-Grid and furring channel up to 1.5" tall. Available for ceiling thicknesses from 0.50" - 2.125".

- TG-FX3-KIT**

### HANGER BAR EXTENDER KIT

Extends hanger bars from 24.0" to 46.0" maximum.

- FRX-HBE-46** Extender, Hanger Bar

### EMERGENCY LIGHTING - REMOTE MOUNT ONLY

During disruption of main power, emergency battery inverter provides temporary 120V or 277V to fixture.

- EMB-S-20/25-120/277-LEDX** 20/25 watt max capacity, 120 or 277 VAC 60Hz, Non-Dimmable
- EMB-S-100-120-LEDX** 100 watt max capacity, 120 VAC 60Hz, Dimmable
- EMB-S-100-277-LEDX** 100 watt max capacity, 277 VAC 60Hz, Dimmable
- EMB-S-250-120/277-LEDX** 250 watt max capacity, 120 or 277 VAC 60Hz, Dimmable

# FRAXION3SLIM WALLWASH

## PERFORMANCE - 3000K

LUMEN PACKAGE	WATTAGE	WALLWASH OPTIC	
		DELIVERED	LPW
80C12A	10	679	67
80C16A	14	934	66
80C23A	21	1286	61
90C10A	10	583	58
90C14A	14	799	57
90C19A	21	1102	52
97C10A	10	519	51
97C12A	14	711	50
97C17A	21	982	46
90W11A	14	719	51
90W13A	14	757	54
90T12A	16	764	48

## TITLE 24 JA8-2019 INDICATED BY SHADING

OUTPUT MULTIPLIER	
CCT	CCT SCALE
2200K (Consult factory for JA8 details)	0.800
2700K	0.957
3000K	1.000
3500K	1.019
4000K	1.030

## WARM DIM PERFORMANCE

WARM DIM TO MIRROR HALOGEN DIMMING PROFILE

90W13A 3200K - 1800K	Full on 100%	Dimmed to 80%	Dimmed to 70%	Dimmed to 50%	Dimmed to 20%	Dimmed to 10%	Dimmed to 2%
CCT (K)	3200	3150	3100	3000	2700	2200	1800
Light Output (Lm)	757	606	495	353	151	76	15
Power (W)	14	11	10	7	3	1.5	0.3
Efficacy (LPW)	54	54	54	54	54	54	54

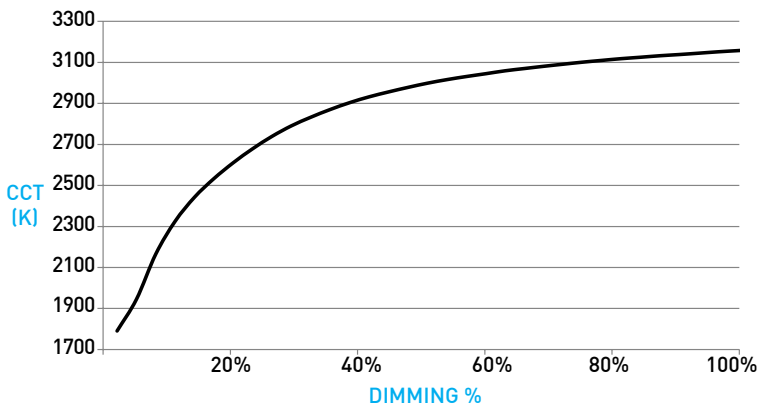

WARM DIM TO MIRROR INCANDESCENT DIMMING PROFILE

90W11A 2700K - 1800K	Full on 100%	Dimmed to 80%	Dimmed to 70%	Dimmed to 50%	Dimmed to 20%	Dimmed to 10%	Dimmed to 2%
CCT (K)	2700	2650	2620	2520	2180	1950	1800
Light Output (Lm)	719	575	503	359	144	72	14
Power (W)	14	11	10	7	3	1.5	0.3
Efficacy (LPW)	51	51	51	51	51	51	51

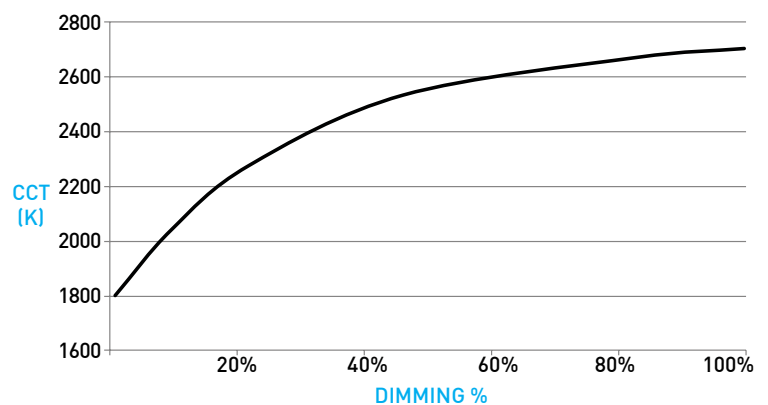

# FRAXION3SLIM WALLWASH

## DOWNLIGHT / HOUSING

- A LED**  
Integral LED module design enables field service / replacement through housing aperture.
- B OPTIC**  
Proprietary wallwash optic integrates Reflection, Refraction and TIR principles.
- C TRIMLESS WOOD SPACERS**  
Provided for Trimless Wood installations; includes (1) 1/16" spacer and (5) 1/8" spacers.
- D TRIM EXTENSION**  
Provided for -2 ceiling thickness; accommodates 2.125" max ceiling thickness.
- E MICROFLANGE PROFILE**  
Features 0.30" flange. Thickness measures 0.06". Installed after ceiling is complete. Requires 3.375" diameter cutout. Wet location features integral silicone gasket.
- F TRIMLESS DRYWALL PROFILE**  
Installs totally flush with the ceiling with no visible trim. Appliqué includes screws for mounting and has 0.06" plaster stop. Not recommended for stucco applications.
- G EFFECTS DEVICES**  
Asymmetrical spread lens, included and sealed in place, combined with angled optic and wide aperture enhance uniformity. Suction tool provided for removal of baffle.
- H BAFFLE**  
Die-cast baffle minimizes aperture glare and conceals view into housing; includes gasket.

## DIMENSIONS / DRAWINGS

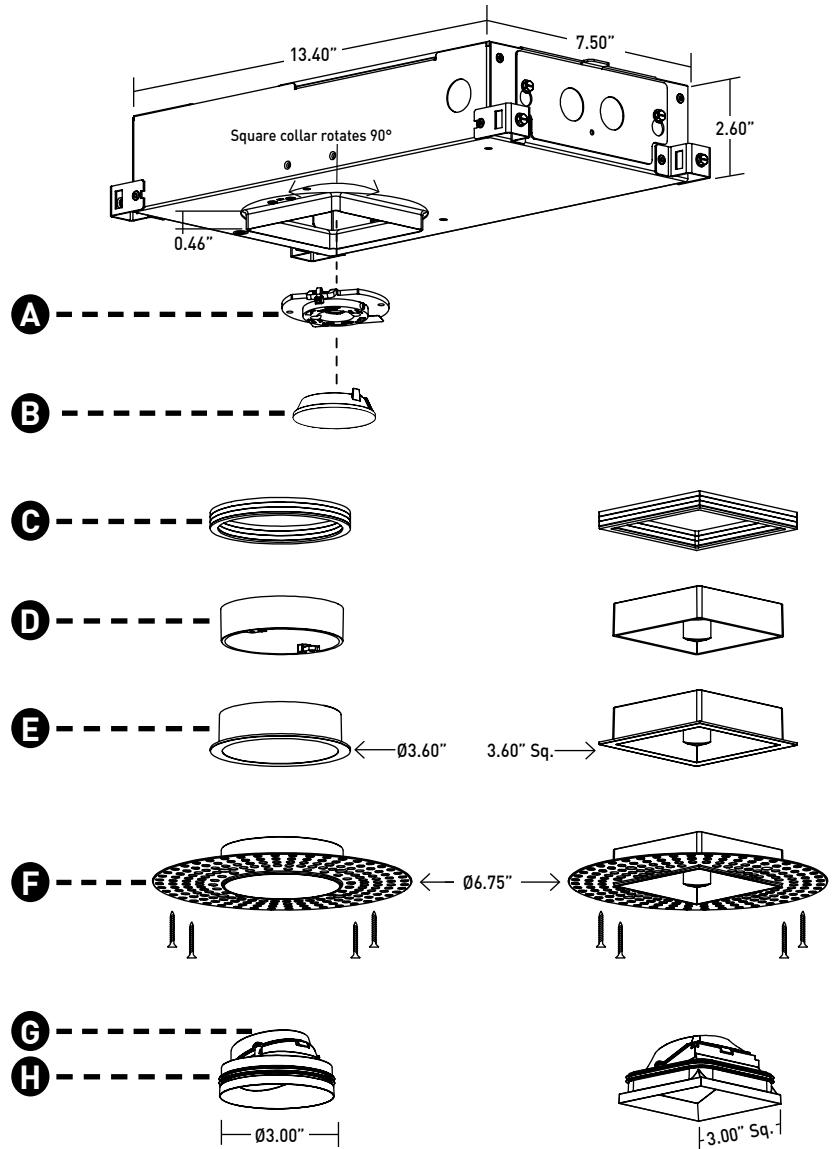

# FRAXION3SLIM WALLWASH

## DOWNLIGHT / HOUSING

- I IC HOUSING**
  - For IC ceilings.
  - No setback from polycell spray foam insulation having max R-Value of 60 on all sides and top of housing.
- J NIC HOUSING**
  - Minimum 0.50" setback from combustible and non-combustible materials on all sides and top of housing.
  - Minimum 3.00" setback from insulation material having max R-Value 30 on all sides and top of housing.
  - Minimum 6.00" setback from polycell spray foam insulation having max R-Value 60.
- K ADJUSTABLE HANGER BAR HEIGHT ACCESSORY**

Provided with ceiling thickness "T" and recommended for installations in T-Grid and furring channel up to 1.5" tall. Hanger bars are installed to adjustable bracket. Allows housing to be raised and lowered; ceiling thickness remains 0.5" to 1.375" max.
- L APPLIQUÉ DETAIL**

Appliqué for plaster floating directly to baffle.
- M REMOTE POWER SUPPLY**

Provided with install Types "V", "W" and "D". Remote power supply provides additional driver options. Consult installation guide for maximum allowable secondary run lengths between PSF3-RMT and fixture. Must be installed in an accessible location.

**I / J**

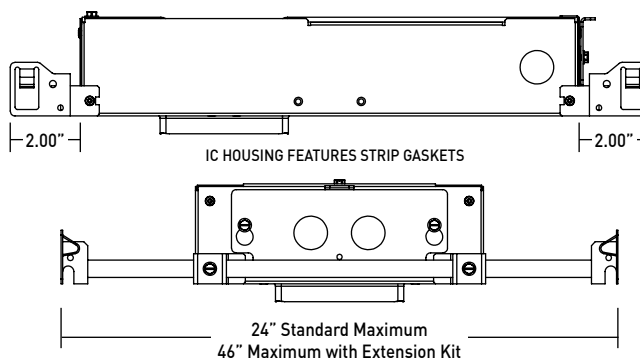

**K**

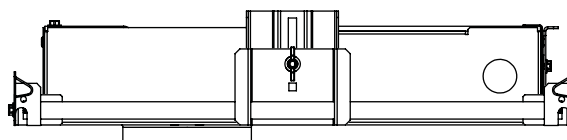

**L**

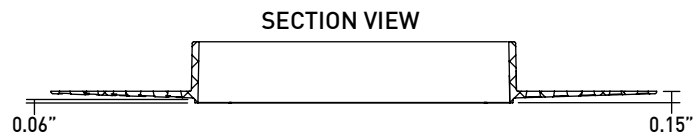

**M**

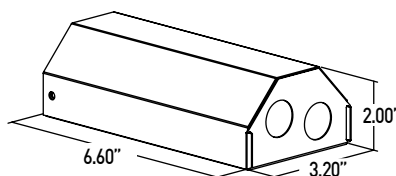

## HOUSING NOTES

- Do not install in environments where ambient temperatures exceed 25°C (77°F).
- Power supply compartment and all splice connections may be serviced from room side.
- Consult factory for spacing requirements for any installations exceeding R-Value 60.
- Hanger bars fitted to short side of housing or long side when TG accessory is specified; extend from 14.0" to 24.0", but may be field cut to accommodate narrow stud spacing. Can be extended up to 46" maximum with FRX-HBE-46 kit.
- Hanger bars and brackets add 4.00" max to the overall dimension, but are exclusive of the setback requirements.
- Housings for round trims feature a round aperture housing collar. Housings for square trims feature a square housing collar that rotates up to 90 degrees for fixture alignment. Housing collars accommodate ceiling thicknesses between 0.50" and 2.125".

# FRAXION3SLIM WALLWASH

## TECHNICAL

### CONSTRUCTION

**Downlight:** Painted finishes are granulated powder coat.

**Housing:** Aluminum and 22 Gauge galvanized steel. Extruded aluminum housing panel to act as heat-sink.

**Remote Power Supply:** 22 Gauge galvanized steel.

**Appliqué:** Zinc alloy.

### LED

2-step MacAdam ellipse LED module available in 80+, 90+ and 97+ CRI configurations in color temperatures of 2200K, 2700K, 3000K, 3500K and 4000K. Average rated lamp life of 50,000 hours. LED and driver assemblies are field-replaceable.

### WARM DIM LED

3-step MacAdam ellipse warm dim LED module available in 90+ CRI configuration. 3200K or 2700K at full brightness, warming to 1800K at full dim. Average rated lamp life of 50,000 hours. LED and driver assemblies are field-replaceable.

### TUNABLE WHITE LED

5-step MacAdam ellipse tunable white LED module available in 90+ CRI configuration. Features tuning range of 2700K to 5000K. Average rated lamp life of 50,000 hours. LED and driver assemblies are field-replaceable.

### POWER SUPPLY PERFORMANCE AND DIMMING INFORMATION

Power Supply	PH	SG	SN	LP	L2	EG	EN	ED	DG	DN	DD
Minimum °C	-20 °C	-10 °C	-10 °C	0 °C	0 °C	-20 °C	-20 °C	-20 °C	-20 °C	-20 °C	-20 °C
Maximum °C	40 °C	40 °C	40 °C	40 °C	40 °C	40 °C	40 °C	40 °C	40 °C	40 °C	40 °C
Dimming %	2.0%	1.0%	1.0%	0.1%	1.0%	0.1%	0.1%	0.1%	0.1%	0.1%	0.1%

Note: For L2, LP, EG and EN drivers consult chart on page 7 to confirm appropriate dimming curve for compatibility with selected control.

### SPACING

Recommended fixture spacing is 36" on center with 36" setback from wall plane.

### LISTING

cTUVus listed to UL1598 standard for Dry / Damp and Wet locations. Chicago Plenum, Airtight and Title 24 JAB-2019 Listed.

### WARRANTY

Manufacturer's 1-year warranty guarantees product(s) listed to be free from defects in material and workmanship under normal use and service. 5-year warranty on LED and power supply to operate with 70% of the original flux and remain within a range of 3 duv. 10-year Lutron Advantage limited warranty available on Lutron equipped systems. Warranty period begins from the date of shipment by Seller and conditional upon the use of manufacturer-supplied power supply. [Consult website for full warranty terms and conditions.](#)

### CHANGE LOG

1.01/12/2021: ADDED 2200K AND 2700K-1800K WARM DIM OFFERINGS.

## DIMMING COMPATIBILITY

### LUTRON DRIVER COMPATIBILITY

Power supply L2 Lutron Product Family	Part No.
Maestro WirelessR 600 W dimmer	MRF2-6ND-120-
Maestro WirelessR 1000 W dimmer	MRF2-10ND-120-
Caséta® Wireless Pro 1000 W dimmer	PD-10NXD-
GRAFIK T™ CL® dimmer	GT-250M- GTJ-250M-
HomeWorks® QS adaptive dimmer	HQRD-6NA-
HomeWorks® QS 600 W dimmer	HQRD-6ND-
HomeWorks® QS 1000 W dimmer	HQRD-10ND-
RadioRA® 2 adaptive dimmer	RRD-6NA-
RadioRA® 2 1000 W dimmer	RRD-10ND
myRoom™ DIN power module	MQSE-4A1-D
HomeWorks® QS DIN power module	LQSE-4A1-D
HomeWorks® QS wallbox power module	HQRJ-WPM-6D-120
HomeWorks® wallbox power module	HWI-WPM-6D-120
GRAFIK Eye® QS control unit	QSGR-, QSGRJ-
GRAFIK Eye® 3000 control unit	GRX-3100- GRX-3500-
RPM-4U module (LCP, HomeWorks® QS, GRAFIK Systems™, Quantum®)	HW-RPM-4U-120 LP-RPM-4U-120
RPM-4A module (LCP, HomeWorks® QS, GRAFIK Systems™, Quantum®)	HW-RPM-4A-120, LP-RPM-4A-120
GP dimming panels	Various
Ariadni CL 250W dimmer	AYCL-253P-
Diva CL 250W dimmer	DVCL-253P- DCSCCL-253P-
Nova T CL 250W dimmer	NTCL-250-
Power supply LP Lutron Product Family	Part No.
PowPak Dimming Modules	RMJ-EC032-DV-B
PowPak Dimming Modules	FCJ/FCJS-ECO
Energi Savr Nodes	QSN-1ECO-S
GRAFIK Eye QS control unit	QSN-2ECO-S
Homeworks QS control unit	QSGRJ- E (wireless) QSGR- E
Quantum Hub	QP2-__ 2C
Quantum Hub	QP2-__ 4C
Quantum Hub	QP2-__ 6C
Quantum Hub	QP2-__ 8C
Homeworks QS power module	LQSE-2ECO-D
myRoom Plus power module	

### eldoLED DRIVER COMPATIBILITY

Power supply EG / EN Dimmer / Switch Control Manufacturer	Family/Model #
Busch-Jaeger	2112U-101
Jung	240-10
Leviton Lighting Controls	IP710-DLX
Lightolier Controls	ZP600FAM120
Lutron Electronics	Nova T® - NTFTV
Lutron Electronics	Diva® - DVTV
Lutron Electronics	Nova® - NFTV
Merten	5729
Pass & Seymour	CD4FB-W
The Watt Stopper	DCLV1
Sensor Switch	nIO EZ
Synergy	ISD BC
Power supply EG / EN Lighting Control System Manufacturer	Family/Model #
Lutron Electronics	GrafixEye® GRX-TVI w GRX3503
Lutron Electronics	Energy Savr Node™ - QSN-4T16-S
Lutron Electronics	TVM2 Module
Crestron®	GLX-DIMFLV8
Crestron®	GLXP-DIMFLV8
Crestron®	GLPAC-DIMFLV4-*
Crestron®	GLPAC-DIMFLV8-*
Crestron®	GLPP-DIMFLVEX-PM
Crestron®	GLPP-1DIMFLV2EX-PM
Crestron®	GLPP-1DIMFLV3EX-PM
Crestron®	DIN-A08
Crestron®	DIN-4DIMFLV4
Crestron®	CLS-EXP-DIMFLV
Crestron®	CLCI-1DIMFLV2EX
ABB	SD/S 2.16.1

