

# TRACK HEAD STANDARD STEM CT2 WALLWASH

Give the most special art, objects, places, and spaces an elegant wash of soft light, with this classic, easy-to-adjust wallwash track head with an integrated kick reflector.

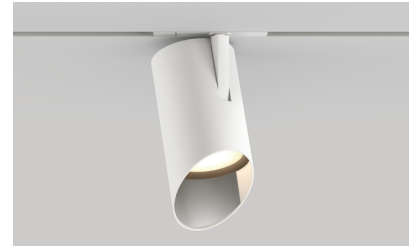



PROJECT NAME:	TYPE:
---------------	-------



## ORDERING INFORMATION - TRACK HEAD



JA8-2019 COMPLIANCE INDICATED BY SHADING

CYLINDER	FIXTURE	RATING	CYLINDER FINISH	BAFFLE FINISH	ADAPTER FINISH	LUMEN PACKAGE	OCT	OPTIC	DRIVER	EFFECTS DEVICE
CT2	AW	1		BK				WW	CE3	W
CT2 3.25"	AW 90° Adjustable Wallwash	1 Dry/Damp	<b>POWDERCOAT</b> WH White BK Black  <b>ALUMINA</b> 01 Brushed Obsidian 02 Matte Obsidian 03 Brushed Dark Patinated Bronze 04 Matte Dark Patinated Bronze 05 Brushed Aged Aluminum 06 Matte Aged Aluminum 07 Brushed Cast Brass 08 Matte Cast Brass 09 Brushed Light Patinated Bronze 10 Matte Light Patinated Bronze  	<b>POWDERCOAT</b> BK Black  	WH White BK Black  	 <b>STATIC WHITE</b> 80C12A 80+ CRI, Delivered Lumens - 826 80C19A 80+ CRI, Delivered Lumens - 1275 90C10A 90+ CRI, Delivered Lumens - 708 90C15A 90+ CRI, Delivered Lumens - 1092 97C09A 97+ CRI, Delivered Lumens - 634 97C14A 97+ CRI, Delivered Lumens - 977   <b>WARM DIM</b> 90W11A 90+ CRI, Delivered Lumens - 863 Incandescent Profile  90W12A 90+ CRI, Delivered Lumens - 869 Standard Profile  *SEE PAGE 3 FOR DETAILED WARM DIM PROFILE COMPARISON.  *ALL DELIVERED LUMEN OUTPUTS AND T24 COMPLIANCE REFLECT 3000K.	22 2200K* <small>*Only available with 90+ CRI</small> 27 2700K 30 3000K 35 3500K 40 4000K  WL 2700K - 1800K  WD 3000K - 1800K	WW Wallwash Optic	INTEGRAL CE3 Electronic 2% ELV / TRIAC 120V	W Wallwash Lens

## ALUMINA FINISHES BY LUCIFER LIGHTING™



\*ALUMINA FINISHES ARE ANODIZED ALUMINUM

## POWDERCOAT FINISHES

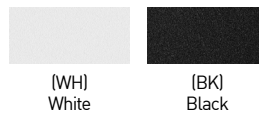

## PART NUMBER NOTES

- CT2 ships as e.g., CT2-AW-1-09BK-90C10A2-W-CE3-WB



# TRACK HEAD STANDARD STEM CT2 WALLWASH

## WALLWASH DESIGN GUIDE

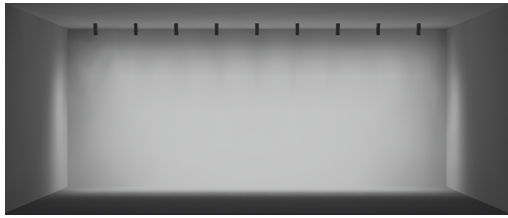

**8FT CEILING**

**36" SETBACK / 36" ON CENTER SPACING / 15° TILT**

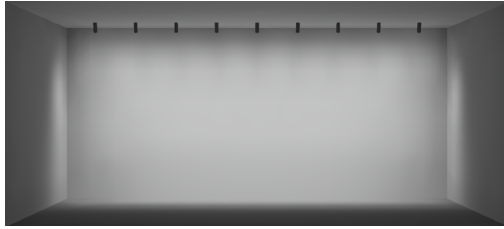

**10FT CEILING**

**36" SETBACK / 36" ON CENTER SPACING / 15° TILT**



**12FT CEILING**

**36" SETBACK / 36" ON CENTER SPACING / 15° TILT**

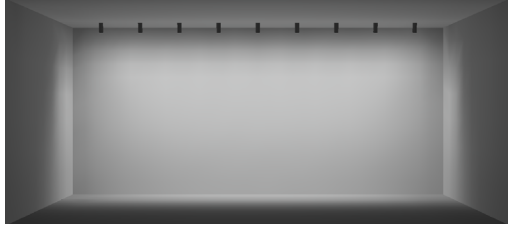

**30" SETBACK / 30" ON CENTER SPACING / 10° TILT**

- AVERAGE FC: 21.92
- MAX / MIN: 4.65
- 10FT CEILING SHOWN / 8-12FT IDEAL
- 9 FIXTURES / 25FT WALL SHOWN

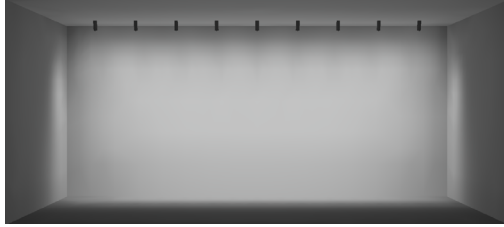

**RECOMMENDED**

**36" SETBACK / 36" ON CENTER SPACING / 15° TILT**

- AVERAGE FC: 20.85
- MAX / MIN: 4.12
- 10FT CEILING SHOWN / 8-12FT IDEAL
- 9 FIXTURES / 30FT WALL SHOWN



**42" SETBACK / 42" ON CENTER SPACING / 20° TILT**

- AVERAGE FC: 19.23
- MAX / MIN: 5.53
- 10FT CEILING SHOWN / 8-12FT IDEAL
- 9 FIXTURES / 35FT WALL SHOWN

### ADDITIONAL SETBACKS AND SPACINGS

ON CENTER SPACING	SETBACK / TILT		
	30" / 10° TILT	36" / 15° TILT	42" / 20° TILT
30"	SHOWN ABOVE	AVERAGE FC: 23.92 MAX / MIN: 4.51	AVERAGE FC: 25.96 MAX / MIN: 4.54
36"	AVERAGE FC: 19.19 MAX / MIN: 4.37	SHOWN ABOVE	AVERAGE FC: 22.64 MAX / MIN: 4.03
42"	AVERAGE FC: 16.19 MAX / MIN: 5.87	AVERAGE FC: 17.67 MAX / MIN: 5.74	SHOWN ABOVE

# TRACK HEAD STANDARD STEM CT2 WALLWASH

## STATIC WHITE PERFORMANCE - 3000K

LUMEN PACKAGE	WATTAGE	WW OPTIC WALLWASH LENS	
		DELIVERED	LPW
80C12A	10	826	83
80C19A	17	1275	75
90C10A	10	708	71
90C15A	17	1092	64
97C09A	10	634	63
97C14A	17	977	57
90W11A	16	863	54
90W12A	16	869	54

OUTPUT MULTIPLIER	
CCT	CCT SCALE
2200K (Contact factory for JA8 details)	0.800
2700K	0.957
3000K	1.000
3500K	1.019
4000K	1.030



JA8-2019 INDICATED BY SHADING

## WARM DIM PERFORMANCE

STANDARD WARM DIM PROFILE

90W12A 3000K - 1800K	Full on 100%	Dimmed to 80%	Dimmed to 70%	Dimmed to 50%	Dimmed to 20%	Dimmed to 10%	Dimmed to 2%
CCT (K)	3000	2950	2920	2775	2375	2000	1800
Light Output (Lm)	869	695	608	434	174	87	17
Power (W)	16	13	11	8	3	1.6	0.3
Efficacy (LPW)	54	54	54	54	54	54	54

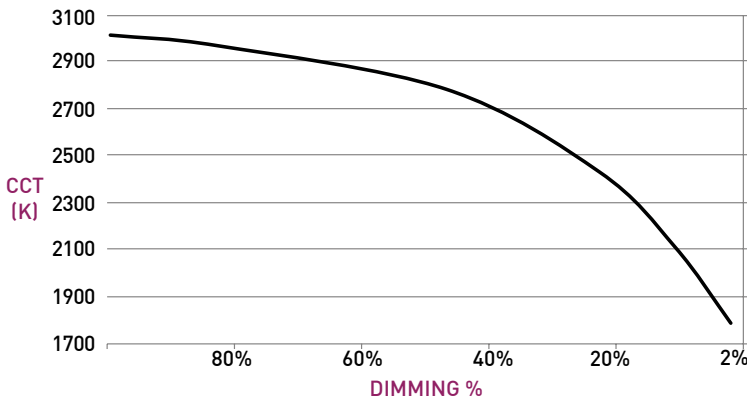

WARM DIM TO MIRROR INCANDESCENT DIMMING PROFILE

90W11A 2700K - 1800K	Full on 100%	Dimmed to 80%	Dimmed to 70%	Dimmed to 50%	Dimmed to 20%	Dimmed to 10%	Dimmed to 2%
CCT (K)	2700	2650	2620	2520	2180	1950	1800
Light Output (Lm)	863	690	604	431	172	86	17
Power (W)	16	13	11	8	3	1.7	0.3
Efficacy (LPW)	54	54	54	54	54	54	54

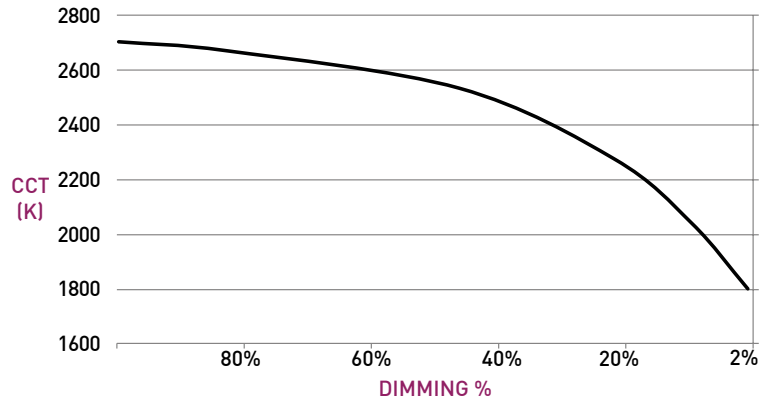

# TRACK HEAD STANDARD STEM CT2 WALLWASH

## TRACK HEAD

- A ADJUSTABILITY**  
Up to 90° tilt and 370° lockable rotation.
- B TRACK ADAPTER**  
Proprietary asymmetric track adapter; compatible with Lucifer Lighting track only. Available in Black and White finishes to match track systems.
- C BODY**  
Power supply integrated into fixture body. Available in powdercoat and Alumina finishes. Body interior **C1** matches exterior finish; interior and exterior finishes cannot be specified differently.
- D OPTIC**  
Proprietary optic for optimal wallwashing.
- E EFFECTS DEVICE**  
Asymmetrical spread lens, included and sealed in place.
- F BAFFLE**  
Baffle minimizes aperture glare and conceals view into fixture. Available in black powdercoat finish.
- G KICK REFLECTOR**  
Miro® Kick reflector uniformly spreads light projected to wall plane.

## DIMENSIONS / DRAWINGS

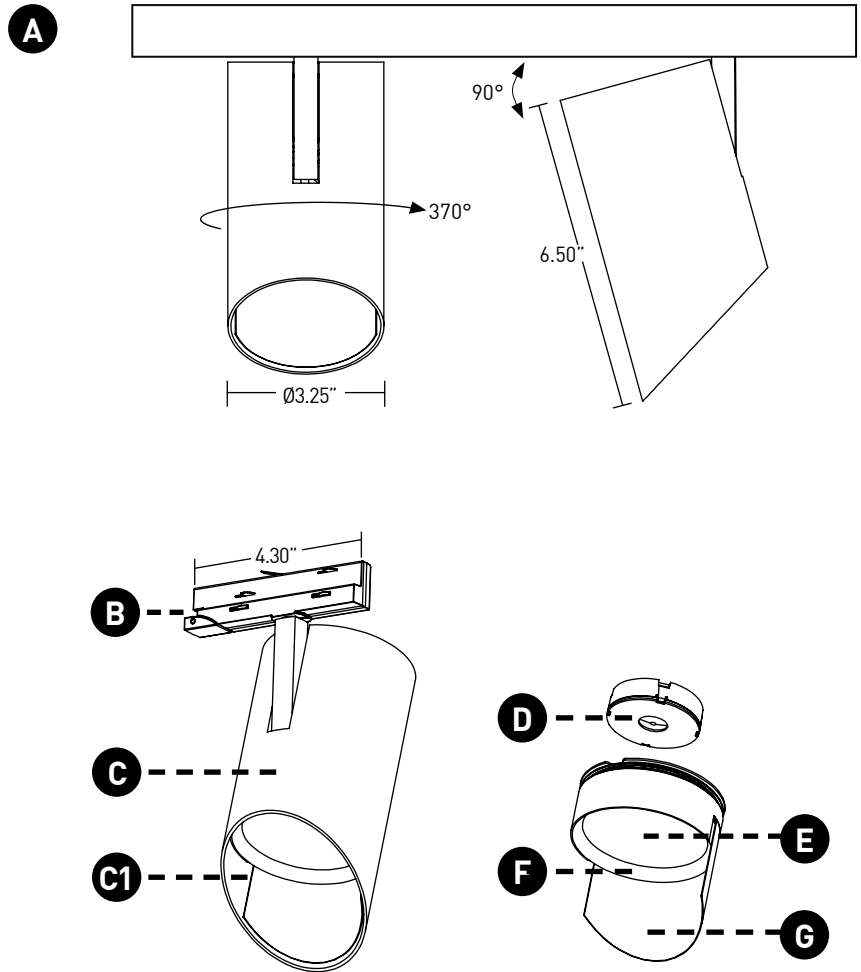

# TRACK HEAD STANDARD STEM CT2 WALLWASH

## TECHNICAL

### CONSTRUCTION

**Track Head:** Machined aluminum body; painted finishes are granulated powder coat; Alumina finishes are anodized.

### STATIC WHITE LED

2-step MacAdam ellipse LED module available in 80+, 90+ and 97+ CRI configurations in color temperatures of 2200K, 2700K, 3000K, 3500K and 4000K. Average rated lamp life: 50,000 hours. LED and driver assemblies are field-replaceable.

### WARM DIM LED

3-step MacAdam ellipse warm dim LED module available in 90+ CRI configuration. 3000K or 2700K at full brightness, warming to 1800K at full dim. Average rated lamp life of 50,000 hours. LED and driver assemblies are field-replaceable.

### POWER SUPPLY PERFORMANCE AND DIMMING INFORMATION

Power Supply	CE3
Minimum °C	-20 °C
Maximum °C	40 °C
Dimming %	2.0%

### MOUNTING

Cylinder track head mounts to recessed, surface or pendant mount track assemblies, specified separately.

### SPACING AND TILT

Trackhead must be tilted to achieve wallwashing effect. Recommended fixture spacing is 36" on center with 36" setback from wall plane with 15° tilt.

### LISTING

Listed to UL1574 standard for Dry locations. JA8-2019 Title 24 listed.

### DECLARE

LBC Red List Approved.

### LIMITED WARRANTY

Manufacturer's Limited Warranty guarantees product(s) listed to be free from defects in material and workmanship under normal use and service for 1-year. LED and power supplies are warranted to operate with 70% of original flux and remain within a range of 3 duv for a period of 5-years. Warranty period begins from the date of shipment by Seller. [Consult website for full warranty terms and conditions.](#)

### CHANGE LOG

1. 10/17/2022: REMOVED CE2 DRIVER AND ADDED CE3 DRIVER.
2. 05/12/2023: ADDED LBC RED LIST APPROVED.