

CYLINDER 2 LVS FIXED SUSPENDED MOUNT

Highlight art, objects, places, spaces, seating areas, and architectural details with a classic profile that offers easy-to-adjust, in-field versatility.

PROJECT NAME:	TYPE:
---------------	-------

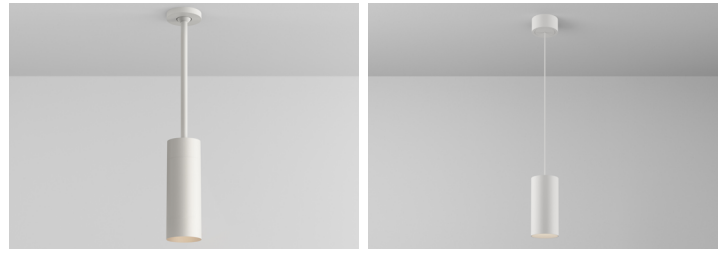

ORDERING INFORMATION - CYLINDER

Quick Ship Product. All rough in components ship within 10 days up to quantities of 100.

CYLINDER	LENGTH	FIXTURE	RATING	CYLINDER FINISH	BAFFLE FINISH	LUMEN PACKAGE	CCT	OPTIC	DRIVER	EFFECTS DEVICE	MOUNTING
			1						LVS		
Dropkit® STEM ASSEMBLY CD2 3.13"	043 2" - 43" Mechanical Dropkit Stem	FB Fixed Body WW Wallwash Unibody	1 Dry / Damp	WH White BK Black	WH White BK Black	STATIC WHITE 80C12A 80+ CRI FB Dlv. Lumens - 727 WW Dlv. Lumens - 807 80C19A 80+ CRI FB Dlv. Lumens - 1121 WW Dlv. Lumens - 1244 80C25A 80+ CRI FB Dlv. Lumens - 1488 WW Dlv. Lumens - 1699 90C10A 90+ CRI FB Dlv. Lumens - 601 WW Dlv. Lumens - 691 90C15A 90+ CRI FB Dlv. Lumens - 926 WW Dlv. Lumens - 1066 90C20A 90+ CRI FB Dlv. Lumens - 1230 WW Dlv. Lumens - 1456 97C09A 97+ CRI FB Dlv. Lumens - 548 WW Dlv. Lumens - 618 97C14A 97+ CRI FB Dlv. Lumens - 845 WW Dlv. Lumens - 905 97C19A 97+ CRI FB Dlv. Lumens - 1121 WW Dlv. Lumens - 1166	22 2200K* *Only available for 90+ CRI)	10 10°* *Only available for 80C12A, 90C10A, and 97C09A. Not available for 2200K)	LVS Low Voltage System	STANDARD EFFECTS DEVICE 4 Soft Focus Lens N No Lens* *(Standard for 10" optic. Not available for Warm Dim) W Wallwash Lens* *(Required and only available for WW fixture) ALTERNATE EFFECTS DEVICE 2 Honeycomb Louver* *(Not available for Warm Dim) 3 Clear Glass Lens* *(Not available for Warm Dim) 5 Frosted Glass Lens 6 Frosted Soft Focus Lens 7 Frosted Linear Spread Lens	ROUGH-IN JBMP 4" Sq. or 4/0 Junction Box Mounting Plate FINISH OUT SMK3 3/0 Surface Mount Kit SMK4 4/0 Surface Mount Kit CMJB 1/2" and 3/4" Conduit Ceiling Mount Junction Box* *(Not available for MA finish. Quick Ship Product for WH and BK finishes only)
	086 45" - 86" Mechanical Dropkit Stem			AB Architectural Bronze* *(Increased lead time)	AB Architectural Bronze* *(Increased lead time)		27 2700K	15 15°			
	129 88" - 129" Mechanical Dropkit Stem			AG Satin Silver* *(Increased lead time)	AG Satin Silver* *(Increased lead time)		30 3000K	25 25°			
	172 131" - 172" Mechanical Dropkit Stem			CF Custom Finish* *(Consult Factory)	CF Custom Finish* *(Consult Factory)		35 3500K	40 40°			
	*All lengths are field cuttable)						40 4000K	60 60°			
PENDANT CP2 3.13"	XXXB Black Cable	FB Fixed Body	1 Dry / Damp	WH White BK Black	BK Black	WARM DIM 90W11A 90+ CRI, Incandescent Profile FB Dlv. Lumens - 844 WW Dlv. Lumens - 733 90W13A 90+ CRI, Halogen Profile FB Dlv. Lumens - 889 WW Dlv. Lumens - 963 *SEE PAGE 3 FOR DETAILED WARM DIM PROFILE COMPARISON. *ALL DELIVERED LUMEN OUTPUTS REFLECT 3000K PAIRED WITH 40° / WW OPTIC AND STANDARD EFFECTS DEVICE.	25 25°	WW Wall wash* *(Required and only available for WW fixture)			
	XXXW White Cable			AB Architectural Bronze* *(Increased lead time)			AG Satin Silver* *(Increased lead time)				40 40°
	Specify cable length in whole inches (Max 180) ex. specify 006B for a 6 inch black cable* *(Cable is field cuttable)			MA Machined Aluminum CF Custom Finish* *(Consult Factory)		60 60°					



PART NUMBER NOTES



- CD2 Adjustable ships as e.g., CY2-AD-1-WH-90C20A2-3-LVS-4
- Stem Assembly ships as CY2-DK-(length)-(finish)
- CP2 ships as e.g., CP2-1-180-WH-90C20A2-3-LVS-4-W
- JBMP ships as [CY2 or CD]-JBMP
- SMK ships as [CY2 or CD]-SMK-(3/0 or 4/0)-(finish)
- CMJB ships as [CY2 or CD]-CMJB-(finish)

CYLINDER 2 LVS FIXED SUSPENDED MOUNT

APPLICATION NOTES

- Lucifer Lighting will not supply a fixture with a POE node or power supply inside the fixture. This allows for easier site install with nodes of 2 or more outputs.
- Consult node manufacturer for maximum remote wiring distances.
- Fixture features 18 Gauge wiring.
- Wiring connections are made on the fixture using customer supplied connectors, ex. wire nuts, push-in connectors, or terminal blocks.
- Confirm node compatibility with factory if it is not listed.
- Customers are responsible for ensuring POE node drive current is set to correct values shown below.
- Customers must ensure voltage range of the proposed POE node encompasses the fixtures complete Vf range, both maximum and minimum. If assistance is required contact LLC rep or factory.

NODE COMPATIBILITY

Manufacturer	Model Number
 Igor Enabling Smart Buildings™	NP50-60-C-F-5
 molex	180996-1001 180996-1002 180996-2001 180996-2002
 PLATFORMATICS	1 Channel Node, POE-LN2-1U-E 2 Channel Node, POE-LN2-2U-E 4 Channel Node, POE-LN2-4U-E

DRIVE CURRENT SPECIFICS

	80C			90C			97C			90W	
	12A	19A	25A	10A	15A	20A	09A	14A	19A	11A	13A
Minimum Vf	30.5	30.5	30.5	30.5	30.5	30.5	30.5	30.5	30.5	30.5	30.5
Maximum Vf	39	39	39	39	39	39	39	39	39	39	39
Current mA	250	400	550	250	400	550	250	400	550	400	400
Wattage W	8.2	13.6	19.4	8.2	13.6	19.4	8.2	13.6	19.4	13.6	13.6

	10 DEGREE OPTIC		
	80C12A	90C10A	97C10A
Minimum Vf	30.5	30.5	30.5
Maximum Vf	39	39	39
Current mA	400	400	400
Wattage W	13.6	13.6	13.6

WIRING DIAGRAM

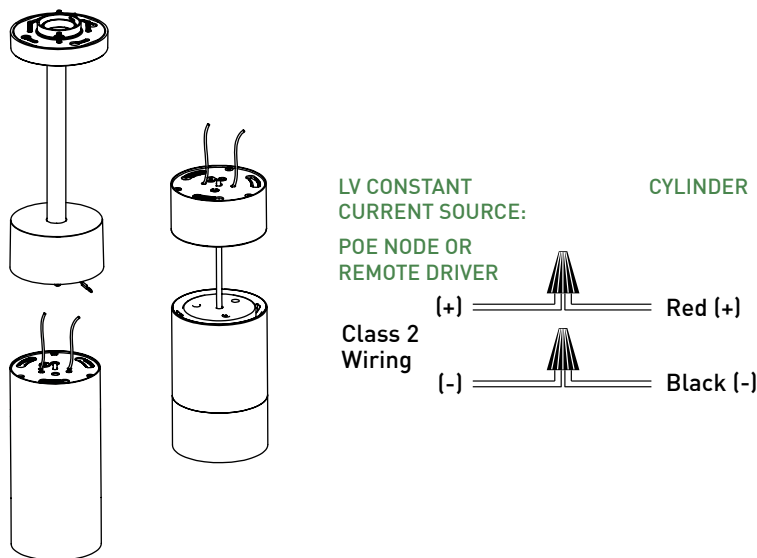

CYLINDER 2 LVS FIXED SUSPENDED MOUNT

ACCESSORIES

FIXED BODY ALTERNATE BAFFLE AND EFFECTS DEVICE

Includes baffle with sealed lens. Must specify baffle finish.

RBA-CY2--HCL** Honeycomb Louver *

*(Not available for Warm Dim)

RBA-CY2--CGL** Clear Glass Lens *

*(Not available for Warm Dim)

RBA-CY2--SFL** Soft Focus Lens

RBA-CY2--FGL** Frosted Glass Lens

RBA-CY2--FSFL** Frosted Soft Focus Lens

RBA-CY2--FLSL** Frosted Linear Spread Lens

** Baffle finish: Specify **WH** for white, **BK** for black, **AG** for satin silver or **AB** for architectural bronze.

PENDANT ALTERNATE EFFECTS DEVICES

HCL-CY2-03 Honeycomb Louver *

*(Not available for Warm Dim)

CGL-CY2-03 Clear Glass Lens *

*(Not available for Warm Dim)

SFL-CY2-03 Soft Focus Lens

FGL-CY2-03 Frosted Glass Lens

FSFL-CY2-03 Frosted Soft Focus Lens

FLSL-CY2-03 Frosted Linear Spread Lens

REPLACEMENT OPTICS

Interchangeable optics accessible by removing snoot or baffle. Not available for Wallwash fixtures.

RO-70-15-1 15° optic *

*(Not available for Warm Dim)

RO-70-25-1 25° optic

RO-70-40-1 40° optic

RO-70-60-1 60° optic

FIXED BODY REPLACEMENT SUCTION TOOL

Included with each CY2-FB order (1 per 10 fixtures).

CY-SQ-TOOL-SUCTION Baffle assembly removal tool

CYLINDER 2 LVS FIXED SUSPENDED MOUNT

STATIC WHITE PERFORMANCE - 3000K

LUMEN PACKAGE	WATTAGE	10° OPTIC NO SOFT FOCUS LENS		15° OPTIC SOFT FOCUS LENS		20° OPTIC SOFT FOCUS LENS		40° OPTIC SOFT FOCUS LENS		60° OPTIC SOFT FOCUS LENS		WALLWASH WALLWASH LENS	
		DELIVERED	LPW	DELIVERED	LPW	DELIVERED	LPW	DELIVERED	LPW	DELIVERED	LPW	DELIVERED	LPW
80C12A	10	1000	58 (17W)	872	87	848	85	727	73	775	78	807	81
80C19A	17	-	-	1345	80	1308	78	1121	67	1196	71	1244	73
80C25A	24	-	-	1786	75	1736	73	1488	62	1587	67	1699	71
90C10A	10	848	49 (17W)	721	72	701	70	601	60	641	64	691	69
90C15A	17	-	-	1112	66	1081	65	926	55	988	59	1066	62
90C20A	24	-	-	1476	62	1435	60	1230	52	1312	55	1456	60
97C09A	10	703	41 (17W)	657	66	639	64	548	55	584	58	618	62
97C14A	17	-	-	1014	61	986	59	845	50	901	54	905	53
97C19A	24	-	-	1346	56	1308	55	1121	47	1196	50	1166	49
90W11A	16	-	-	-	-	913	57	844	49	876	55	733	43
90W13A	16	-	-	-	-	961	60	889	56	922	58	963	57

OUTPUT MULTIPLIER	
CCT	CCT SCALE
2200K	0.800
2700K	0.957
3000K	1.000
3500K	1.019
4000K	1.030

LIGHT LOSS FACTOR MULTIPLIER	
No Lens	1.05
CGL	1.05
SFL	1.00
FGL	0.90
FSFL	0.87
FLSL	0.83
HCL	0.65

WARM DIM PERFORMANCE - SOFT FOCUS LENS - 40° OPTIC

WARM DIM TO MIRROR HALOGEN DIMMING PROFILE

90W13A 3200K - 1800K	Full on 100%	Dimmed to 80%	Dimmed to 70%	Dimmed to 50%	Dimmed to 20%	Dimmed to 10%	Dimmed to 2%
CCT (K)	3200	3150	3100	3000	2700	2200	1800
Light Output (Lm)	889	711	622	444	178	89	18
Power (W)	16	13	11	8	3	1.7	0.3
Efficacy (LPW)	56	56	56	56	56	56	56

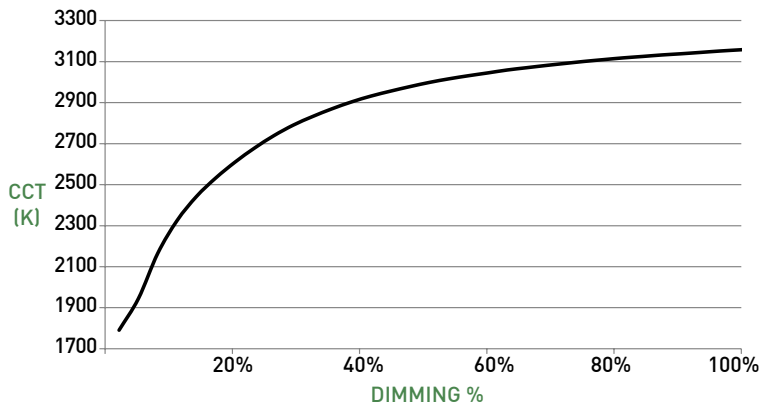

WARM DIM TO MIRROR INCANDESCENT DIMMING PROFILE

90W11A 2700K - 1800K	Full on 100%	Dimmed to 80%	Dimmed to 70%	Dimmed to 50%	Dimmed to 20%	Dimmed to 10%	Dimmed to 2%
CCT (K)	2700	2650	2620	2520	2180	1950	1800
Light Output (Lm)	844	675	591	422	169	84	17
Power (W)	16	13	11	8	3	1.7	0.3
Efficacy (LPW)	52	52	52	52	52	52	52

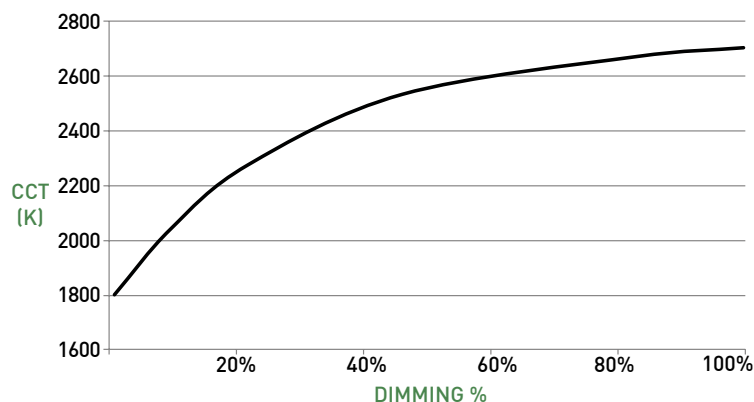

CYLINDER 2 LVS FIXED SUSPENDED MOUNT

Dropkit STEM ASSEMBLY

- A LUMINAIRE**
Body with integrated heat sink and LED. Conceals mounting hardware. Power supply must be remote mount.
- B STANDARD OPTICS**
Proprietary optics available in 10°, 15°, 25°, 40° & 60° beams.
- WALLWASH OPTIC**
Precision tuned optic provides uniform wallwashing effect.
- C EFFECTS DEVICE**
Cylinder baffle assembly can accept 1 lens. Soft focus lens, no lens or wallwash lens standard; lenses sealed in place.
- D BAFFLE**
Baffle minimizes aperture glare and conceals view into fixture. Suction tool provided for removal of CY2-FB baffle.
- E Dropkit**
 - Field cuttable rigid stem for suspending fixture at desired height. Provides stable base to allow preferred fixture tilt, while maintaining vertical stem position.
 - Ball joint allows up to 45° tilt for sloped ceilings and can be locked once stem is positioned vertically.
 - Four 43" sections available; 172" maximum standard length.
 - Length adjustment occurs in lower canopy.
 - Wiring for kit provided by others.

DIMENSIONS / DRAWINGS

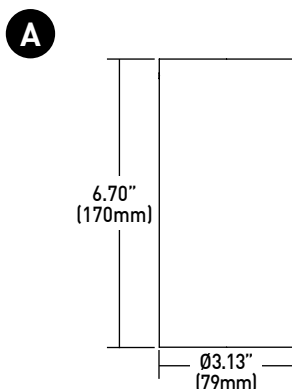

FIXED BODY

WALLWASH UNIBODY

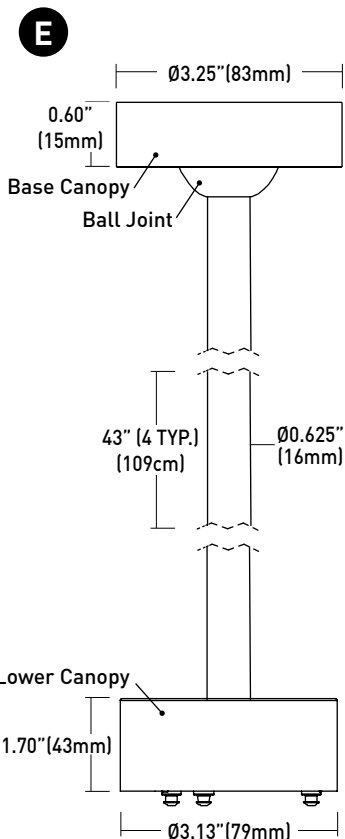
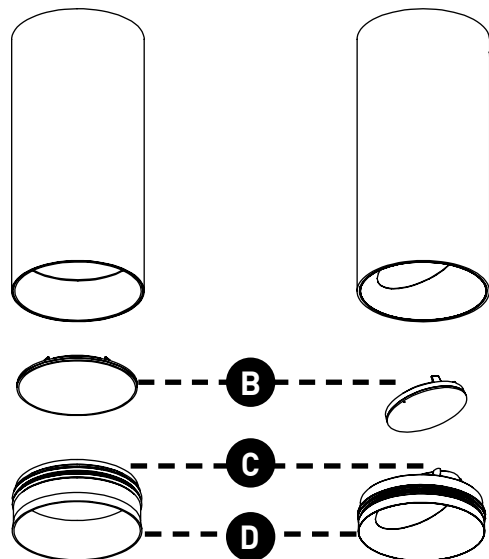

CYLINDER 2 LVS FIXED SUSPENDED MOUNT

PENDANT

DIMENSIONS / DRAWINGS

- F CANOPY**
Die-cast 1.60" (41mm) canopy accommodates flat and slope ceiling conditions. Conceals hidden twist-on mounting hardware. Power supply must be remote mount.
- G CABLE**
Black and white wiring harness available; up to 180.0" length; cable may be cut in field.
- H LUMINAIRE**
Die-cast body with integral heat sink and LED.
- I OPTICS**
Proprietary optics available in 10°, 15°, 25°, 40° & 60° beams.
- J EFFECTS DEVICE**
Cylinder baffle assembly can accept 1 lens; soft focus lens or no lens standard and sealed in place.
- K BAFFLE**
Threaded removable cowling provides virtually seamless joint with fixture body.

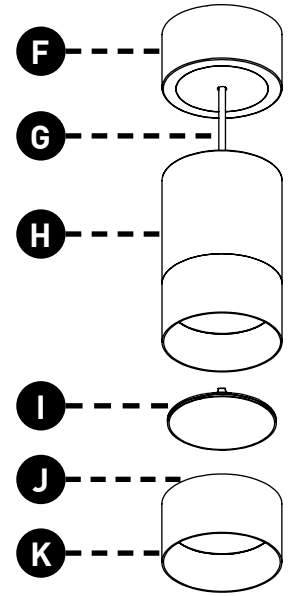
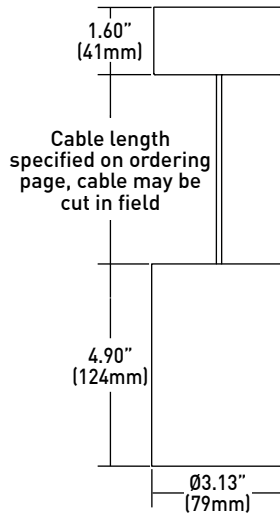

Dropkit AND PENDANT MOUNTING

- L JBMP**
Mounting plate (concealed) for standard 4" square or 4" 4/0 j-box. To be installed during rough-in prior to substrate. Fixture to mount flush with minimalist transition to ceiling.
- M SMK3**
Surface mount kit includes mounting plate and 4" concealer plate that installs between fixture and standard 3" 3/0 j-box for existing applications where standard j-box cutout is to be concealed.
- N SMK4**
Surface mount kit includes mounting plate and 5" concealer plate that installs between fixture and standard 4" 4/0 j-box for existing applications where standard j-box cutout is to be concealed.
- O CMJB**
Ceiling mount junction box perfectly matches the cylinder profile for a continuous, integrated look where exposed ceiling mount junction box and conduit applications apply. For use with 1/2" and 3/4" EMT conduit only. Features two conduit entrances on either side and one conduit knockout on top of j-box. J-box is IP10 rated; painted finishes only. Blank off plugs included.

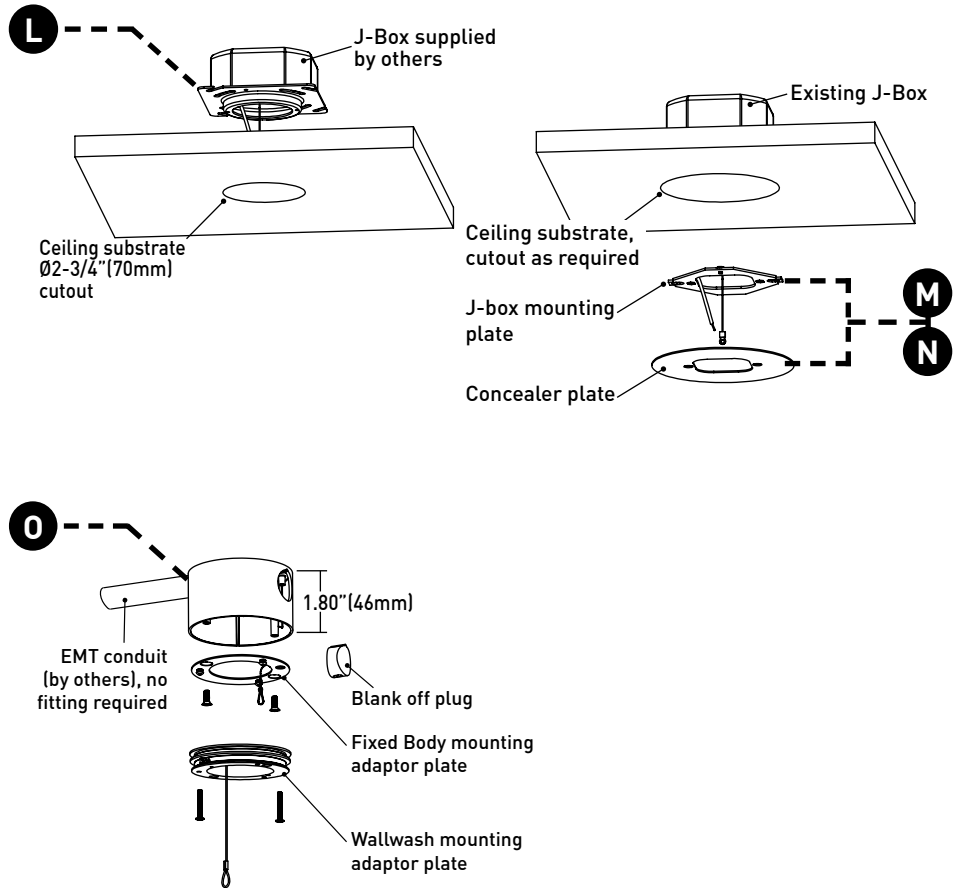

MOUNTING NOTES

- JBMP and SMK-3/0 & 4/0 not recommended for use with pancake style j-box.

CYLINDER 2 LVS FIXED SUSPENDED MOUNT

TECHNICAL

CONSTRUCTION

Cylinder: Die-cast or Machined aluminum body; extruded aluminum internal heat-sink; painted finishes are granulated powder coat.

Dropkit Stem Assembly: Die-cast aluminum canopies and extruded aluminum stems; painted finishes are granulated powder coat.

CMJB: Die-cast aluminum body; painted finishes are granulated powder coat.

STATIC WHITE LED

2-step MacAdam ellipse LED module available in 80+, 90+ and 97+ CRI configurations in color temperatures of 2200K, 2700K, 3000K, 3500K and 4000K. Average rated lamp life of 50,000 hours. LED and driver assemblies are field-replaceable.

WARM DIM LED

3-step MacAdam ellipse warm dim LED module available in 90+ CRI configuration. 3200K or 2700K at full brightness, warming to 1800K at full dim. Average rated lamp life of 50,000 hours. LED and driver assemblies are field-replaceable.

WALLWASH SPACING

Factory recommends 48" (1219mm) spacing on center with 36" (914mm) setback from wall plane.

MOUNTING

Pendant is supplied with a mounting adaptor plate, which integrates with specified mounting component. Dropkit Stem integrates directly with specified mounting component. Both applications provide a minimalist transition from standard 4/0 or 4" square junction boxes and accommodating ceiling thicknesses of 0.44" (12mm) to 0.75" (19mm). Ceiling-mount junction box available for 1/2" (13mm) and 3/4" (19mm) conduit and feature concealed internal clamps for clean fitting-free conduit exit and entry.

LISTING

cTUVus listed to UL2108 standard for Dry / Damp (IP10) locations.

WARRANTY

Manufacturer's 1-year warranty guarantees product(s) listed to be free from defects in material and workmanship under normal use and service. 5-year warranty on LED to operate with 70% of the original flux and remain within a range of 3 duv. Warranty period begins from the date of shipment by Seller. [Consult website for full warranty terms and conditions.](#)

CHANGE LOG

- 04/27/2021: ADDED WALLWASH UNIBODY OFFERING.
- 01/12/2021: ADDED 2200K, 2700K-1800K WARM DIM AND 10 DEGREE OPTIC OFFERINGS.