

# TRACK HEAD INT MONOPOINT INSPIRED CTM1 WALLWASH

Give the most special art, objects, places, and spaces an elegant wash of soft light, with this classic, easy-to-adjust wallwash track head with an integrated kick reflector.

PROJECT NAME:	TYPE:
---------------	-------

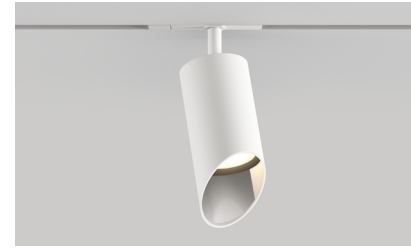

## ORDERING INFORMATION - TRACK HEAD

CYLINDER	FIXTURE	STEM LENGTH	RATING	BODY FINISH	BAFFLE FINISH	STEM FINISH	ADAPTER FINISH	LUMEN PACKAGE	CCT	OPTIC(UGR)	DRIVER	MEDIA
CTM1	W	SL	1		BK					WW	IE2	W
CTM1 2.60"	W Wallwash	LENGTHS SL 1.4" Standard  *STEMS ARE NOT FIELD CUTTABLE	1 Dry	<b>POWDERCOAT</b> WH White BK Black <b>ALUMINA</b> 01 Brushed Obsidian 02 Matte Obsidian 03 Brushed Dark Patinated Bronze 04 Matte Dark Patinated Bronze 05 Brushed Aged Aluminum 06 Matte Aged Aluminum 07 Brushed Cast Brass 08 Matte Cast Brass 09 Brushed Light Patinated Bronze 10 Matte Light Patinated Bronze	<b>POWDERCOAT</b> BK Black	<b>POWDERCOAT</b> WH White BK Black <b>ALUMINA</b> CONSULT FACTORY FOR ALUMINA FINISHES	WH White BK Black	<b>STATIC WHITE</b> 80S11A 80+ CRI, Lumens Delivered - 775 90S11A 90+ CRI, Lumens Delivered - 666 97S11A 97+ CRI, Lumens Delivered - 585  <b>WARM DIM</b> 90W11A 90+ CRI, 11 Watts Incandescent Profile Lumens Delivered - 530 Halogen Profile Lumens Delivered - 538 SEE PAGE 3 FOR WARM DIM PROFILE COMPARISON.	24 2400K* * (90+ CRI only) 27 2700K 30 3000K 35 3500K 40 4000K  WL 2600K - 1800K WD 2900K - 1800K	WW Wallwash Optic (<19)	<b>INTEGRAL</b> IE2 Electronic 3% ELV / TRIAC 220V-240V	W Wallwash Lens

### PART NUMBER NOTES

- CTM1 ships as e.g., CTM1WSL1WHBKWH90S11A30WWIE2WB

### POWDERCOAT FINISHES

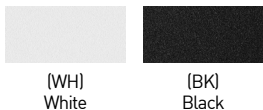

### ALUMINA FINISHES BY LUCIFER LIGHTING™



# TRACK HEAD INT J-HINGE STEM CTM1 WALLWASH

## WALLWASH DESIGN GUIDE

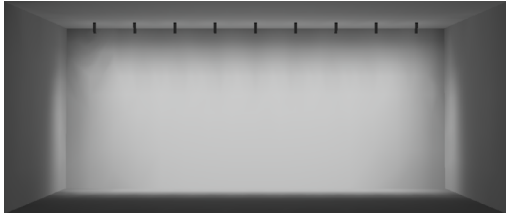

**8FT CEILING**

**36" SETBACK / 36" ON CENTER SPACING / 15° TILT**

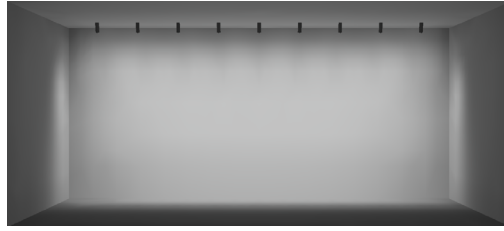

**10FT CEILING**

**36" SETBACK / 36" ON CENTER SPACING / 15° TILT**



**12FT CEILING**

**36" SETBACK / 36" ON CENTER SPACING / 15° TILT**



**30" SETBACK / 30" ON CENTER SPACING / 10° TILT**

- AVERAGE FC: 15.34
- MAX / MIN: 5.21
- 10FT CEILING SHOWN / 8-12FT IDEAL
- 9 FIXTURES / 25FT WALL SHOWN



**RECOMMENDED**

**36" SETBACK / 36" ON CENTER SPACING / 15° TILT**

- AVERAGE FC: 14.57
- MAX / MIN: 4.46
- 10FT CEILING SHOWN / 8-12FT IDEAL
- 9 FIXTURES / 30FT WALL SHOWN

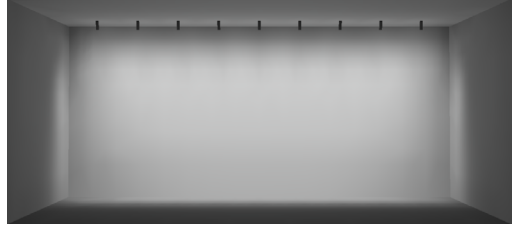

**42" SETBACK / 42" ON CENTER SPACING / 20° TILT**

- AVERAGE FC: 19.20
- MAX / MIN: 5.65
- 10FT CEILING SHOWN / 8-12FT IDEAL
- 9 FIXTURES / 35FT WALL SHOWN

### ADDITIONAL SETBACKS AND SPACINGS

ON CENTER SPACING	SETBACK / TILT		
	30" / 10° TILT	36" / 15° TILT	42" / 20° TILT
30"	SHOWN ABOVE	AVERAGE FC: 16.71 MAX / MIN: 4.71	AVERAGE FC: 18.02 MAX / MIN: 4.49
36"	AVERAGE FC: 13.42 MAX / MIN: 5.00	SHOWN ABOVE	AVERAGE FC: 15.75 MAX / MIN: 4.19
42"	AVERAGE FC: 16.24 MAX / MIN: 5.89	AVERAGE FC: 17.68 MAX / MIN: 5.74	SHOWN ABOVE

# TRACK HEAD INT J-HINGE STEM CTM1 WALLWASH

## STATIC WHITE PERFORMANCE - 3000K

LUMEN PACKAGE	WATTAGE	WW OPTIC WALLWASH LENS	
		DELIVERED	LPW
80S11A	11	775	70
90S11A	11	666	61
97S11A	11	585	53
90W10AL (2600K-1800K)	10	530	53
90W10AD (2900K-1800K)	10	538	53

### OUTPUT MULTIPLIER

CCT	CCT SCALE
2400K	0.85
2700K	0.97
3000K	1.00
3500K	1.03
4000K	1.08

### UNIFIED GLARE RATING

WALLWASH OPTIC
>19

Part L 75+ LPW configurations comply with residential Part L  
95+ LPW configurations comply with commercial Part L

## WARM DIM PERFORMANCE

### INCANDESCENT DIMMING PROFILE

90W10AL 2600K - 1800K	Full on 100%	Dimmed to 80%	Dimmed to 70%	Dimmed to 50%	Dimmed to 20%	Dimmed to 10%	Dimmed to 2%
CCT (K)	2600	2550	2520	2450	2200	1925	1800
Light Output (Lm)	530	424	371	265	106	53	10
Power (W)	11	8.8	7.7	5.5	2.2	1.1	.22
Efficacy (LPW)	53	53	53	53	53	53	53

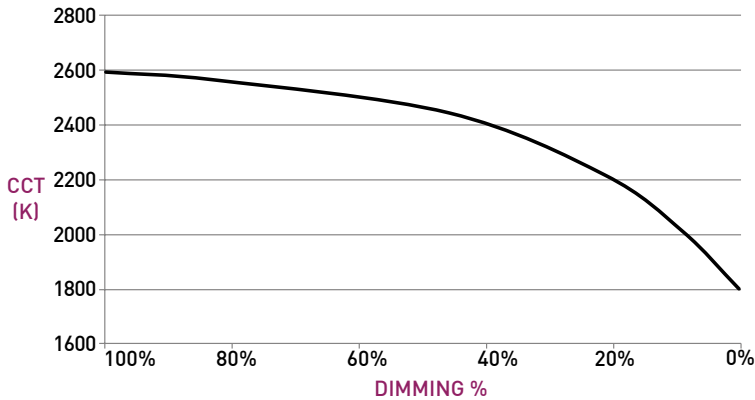

### HALOGEN WARM DIM PROFILE

90W10AD 2900K - 1800K	Full on 100%	Dimmed to 80%	Dimmed to 70%	Dimmed to 50%	Dimmed to 20%	Dimmed to 10%	Dimmed to 2%
CCT (K)	2900	2850	2800	2720	2350	1975	1800
Light Output (Lm)	538	430	376	269	107	53	10
Power (W)	11	8.8	7.7	5.5	2.2	1.1	.22
Efficacy (LPW)	53	53	53	53	53	53	53

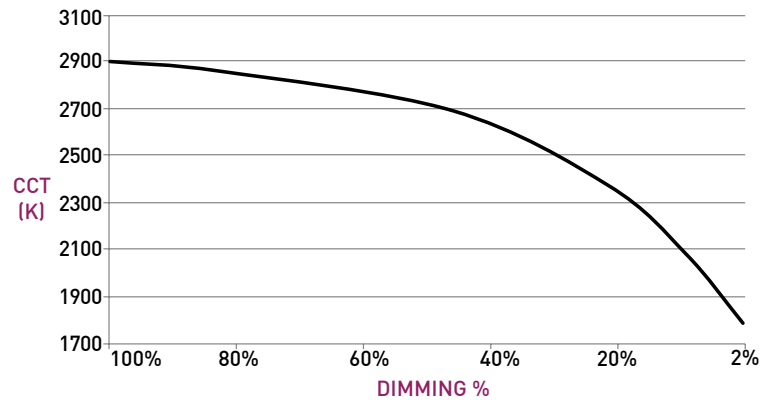

# TRACK HEAD INT J-HINGE STEM CTM1 WALLWASH

## TRACK HEAD

- A ADJUSTABILITY**  
Up to 90° lockable tilt and 370° lockable rotation.
- B TRACK ADAPTER**  
Proprietary asymmetric track adapter; compatible with Lucifer Lighting track only. Available in Black and White finishes to match track systems.
- C STEM**  
Standard length is 1.4". Stem is not field cuttable. Powdercoat finishes standard, consult factory for Alumina finishes.
- D BODY**  
Power supply integrated into fixture body. Available in powdercoat and Alumina finishes. Body interior **D1** matches exterior finish; interior and exterior finishes cannot be specified differently.
- E OPTIC**  
Proprietary optic for optimal wallwashing.
- F MEDIA**  
Asymmetrical spread lens, included and sealed in place.
- G BAFFLE**  
Baffle minimizes aperture glare and conceals view into fixture. Available in black powdercoat finish.
- H KICK REFLECTOR**  
Miro® Kick reflector uniformly spreads light projected to wall plane. Kick reflector not available with painted or Alumina finishes.

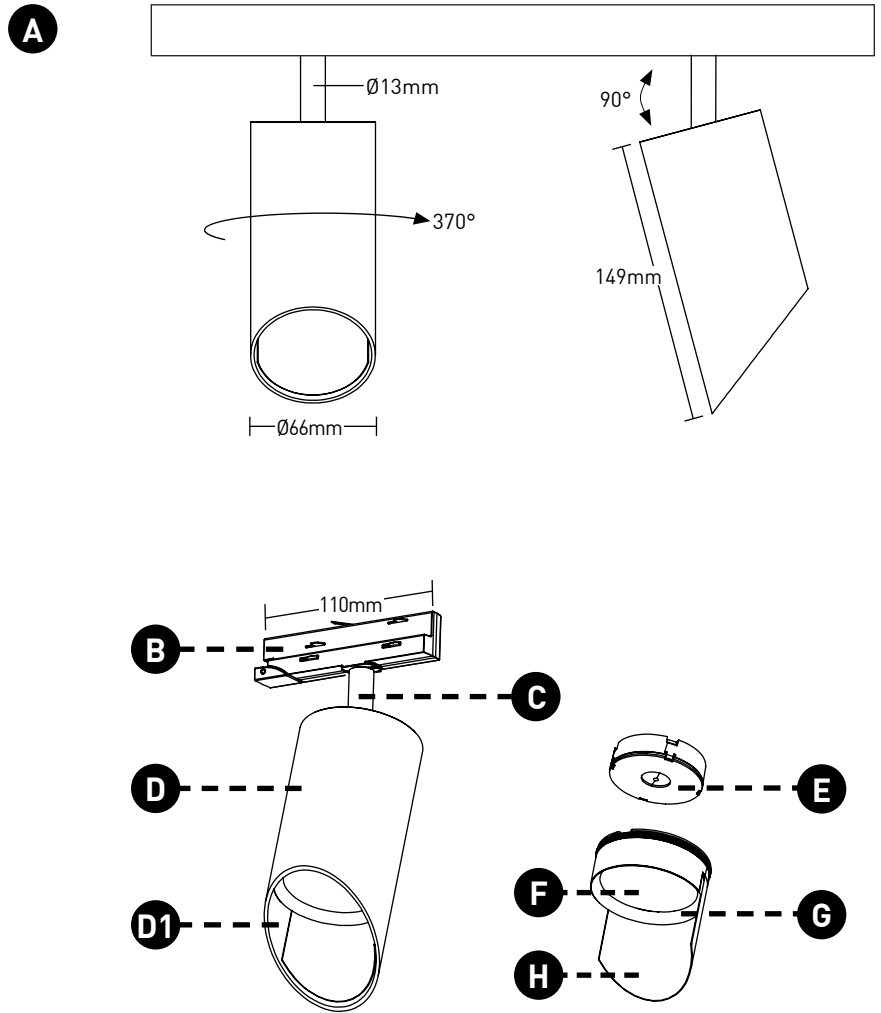

# TRACK HEAD INT J-HINGE STEM CTM1 WALLWASH

## TECHNICAL

### CONSTRUCTION

**Track Head:** Machined aluminum body; painted finishes are granulated powder coat; Alumina finishes are anodized aluminum.

### STATIC WHITE LED

2-step MacAdam ellipse LED module available in 80+, 90+ and 97+ CRI configurations in color temperatures of 2700K, 3000K, 3500K and 4000K. 3-step MacAdam ellipse LED module available in 90+ CRI configuration in color temperature of 2400K. Average rated lamp life of 50,000 hours.

### WARM DIM LED

3-step MacAdam ellipse warm dim LED module available in 90+ CRI configuration. 2900K or 2600K at full brightness, warming to 1800K at full dim. Average rated lamp life of 50,000 hours.

### POWER SUPPLY PERFORMANCE AND DIMMING INFORMATION

Power Supply	IE2
Minimum °C	-20 °C
Maximum °C	40 °C
Dimming %	3.0%

### MOUNTING

Cylinder track head mounts to Lucifer Lighting Company recessed, surface or pendant mount track assemblies, specified separately.

### SPACING AND TILT

Trackhead must be tilted to achieve wallwashing effect. Recommended fixture spacing is 914mm (36") on center with 914mm (36") setback from wall plane with 15° tilt.

### LISTING

Track heads and drivers CE Listed for dry locations. Drivers ENEC and CB Listed.

### PART L

Part L compliant for all 75+ LPW residential and 95+ LPW commercial configurations.

### LIMITED WARRANTY

Manufacturer's Limited Warranty guarantees product(s) listed to be free from defects in material and workmanship under normal use and service for 1-year. LED and power supplies are warranted to operate with 70% of original flux and remain within a range of 3 duv for a period of 5-years. Warranty period begins from the date of shipment by Seller. [Consult website for full warranty terms and conditions.](#)

### CHANGE LOG

- 03/16/2023: REMOVED ALL STEM LENGTH OFFERINGS EXCEPT STANDARD 1.4" LENGTH.
- 05/12/2023: ADDED LBC RED LIST APPROVED.
- 08/08/2023: ADDED NEW LED AND OPTIC SYSTEM.
- 02/08/2024: ADDED 2400K AND WARM DIM OFFERINGS.
- 2/15/2024: PART L COMPLIANCE ADDED