

TRACK HEAD MONOPOINT INSPIRED CTM1 WALLWASH

PROJECT NAME:	TYPE:
---------------	-------



Give the most special art, objects, places, and spaces an elegant wash of soft light, with this classic, easy-to-adjust wallwash track head with an integrated kick reflector.

ORDERING INFORMATION - TRACK HEAD



JA8-2022 COMPLIANCE INDICATED BY SHADING

CYLINDER	FIXTURE	STEM LENGTH	RATING	BODY FINISH	BAFFLE FINISH	STEM FINISH	ADAPTER FINISH	CRI / WATTAGE PACKAGE	CCT	OPTIC (UGR)	DRIVER	MEDIA
CTM1	W		1		BK					WW	CE3	W
CTM1 2.60"	W Wallwash	LENGTHS SL 1.4" Standard 04 4" 06 6" 08 8" CUSTOM LENGTHS XX Specify in 1" increments between 2"-7" (Ex. 2" = 02)* *(Increased lead time) STEMS ARE NOT FIELD CUTTABLE	1 Dry	POWDERCOAT WH White BK Black AB Architectural Bronze AG Satin Silver AU Cashmere Gold BB Burnt Bronze ALUMINA 01 Brushed Obsidian 02 Matte Obsidian 03 Brushed Dark Patinated Bronze 04 Matte Dark Patinated Bronze 05 Brushed Aged Aluminum 06 Matte Aged Aluminum 07 Brushed Cast Brass 08 Matte Cast Brass 09 Brushed Light Patinated Bronze 10 Matte Light Patinated Bronze	POWDERCOAT BK Black	POWDERCOAT WH White BK Black AB Architectural Bronze AG Satin Silver AU Cashmere Gold BB Burnt Bronze ALUMINA CONSULT FACTORY FOR ALUMINA FINISHES	WH White BK Black	STATIC WHITE 80S11A 80+ CRI, Lumens Delivered - 775 90S11A 90+ CRI, Lumens Delivered - 666 97S11A 97+ CRI, Lumens Delivered - 585 WARM DIM 90L11A 90+ CRI, 11 Watts Incandescent Profile Lumens Delivered - 647 Halogen Profile Lumens Delivered - 679 SEE PAGE 3 FOR WARM DIM PROFILE COMPARISON.	24 2400K* *(90+ CRI only) 27 2700K 30 3000K 35 3500K 40 4000K WL 2700K - 1800K WD 3000K - 1800K	WW Wallwash Optic (<19)	INTEGRAL CE3 Electronic 3% ELV / TRIAC 120V	W Wallwash Lens

LUMENS DELIVERED AND T24 COMPLIANCE REFLECT 3000K.

ALUMINA FINISHES BY LUCIFER LIGHTING™



POWDERCOAT FINISHES

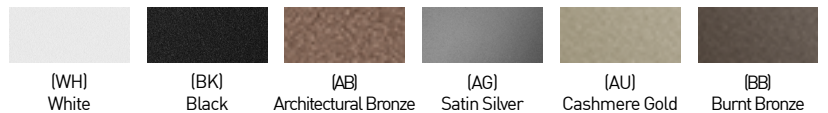

TRACK HEAD MONOPOINT INSPIRED CTM1 WALLWASH

WALLWASH DESIGN GUIDE

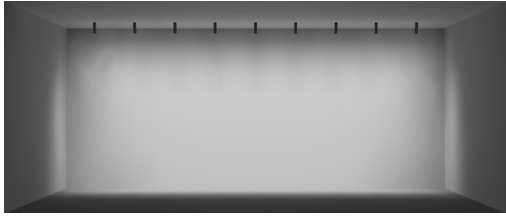

8FT CEILING

36" SETBACK / 36" ON CENTER SPACING / 15° TILT

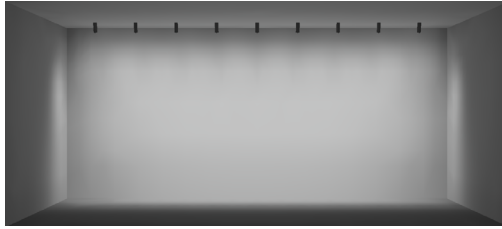

10FT CEILING

36" SETBACK / 36" ON CENTER SPACING / 15° TILT

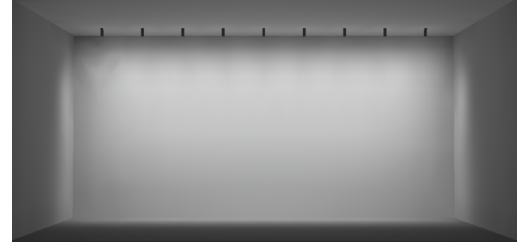

12FT CEILING

36" SETBACK / 36" ON CENTER SPACING / 15° TILT



30" SETBACK / 30" ON CENTER SPACING / 10° TILT

- AVERAGE FC: 15.34
- MAX / MIN: 5.21
- 10FT CEILING SHOWN / 8-12FT IDEAL
- 9 FIXTURES / 25FT WALL SHOWN



RECOMMENDED

36" SETBACK / 36" ON CENTER SPACING / 15° TILT

- AVERAGE FC: 14.57
- MAX / MIN: 4.46
- 10FT CEILING SHOWN / 8-12FT IDEAL
- 9 FIXTURES / 30FT WALL SHOWN

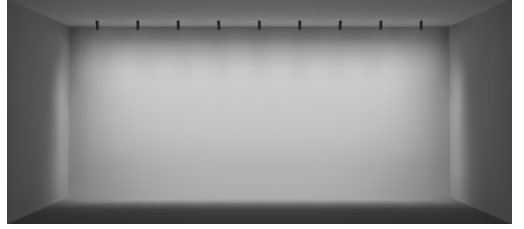

42" SETBACK / 42" ON CENTER SPACING / 20° TILT

- AVERAGE FC: 19.20
- MAX / MIN: 5.65
- 10FT CEILING SHOWN / 8-12FT IDEAL
- 9 FIXTURES / 35FT WALL SHOWN

ADDITIONAL SETBACKS AND SPACINGS

ON CENTER SPACING	SETBACK / TILT		
	30" / 10° TILT	36" / 15° TILT	42" / 20° TILT
30"	SHOWN ABOVE	AVERAGE FC: 16.71 MAX / MIN: 4.71	AVERAGE FC: 18.02 MAX / MIN: 4.49
36"	AVERAGE FC: 13.42 MAX / MIN: 5.00	SHOWN ABOVE	AVERAGE FC: 15.75 MAX / MIN: 4.19
42"	AVERAGE FC: 16.24 MAX / MIN: 5.89	AVERAGE FC: 17.68 MAX / MIN: 5.74	SHOWN ABOVE

TRACK HEAD MONOPOINT INSPIRED CTM1 WALLWASH

STATIC WHITE PERFORMANCE - 3000K



JA8-2022 INDICATED BY SHADING

LUMEN PACKAGE	WATTAGE	WW OPTIC WALLWASH LENS	
		DELIVERED	LPW
80S11A	11	775	70
90S11A	11	666	61
97S11A	11	585	53
90L11AL (2600K-1800K)	11	647	59
90L11AD (2900K-1800K)	11	679	62

OUTPUT MULTIPLIER	
CCT	CCT SCALE
2400K	0.85
2700K	0.97
3000K	1.00
3500K	1.03
4000K	1.08

UNIFIED GLARE RATING	
WALLWASH OPTIC	
>19	

WARM DIM PERFORMANCE

INCANDESCENT PROFILE

90L11AWL 2700K - 1800K	Full on 100%	Dimmed to 80%	Dimmed to 70%	Dimmed to 50%	Dimmed to 20%	Dimmed to 10%	Dimmed to 2%
CCT (K)	2700	2700	2700	2600	2200	1900	1800
Light Output (Lm)	647	518	453	324	129	65	13
Power (W)	11	8.8	7.7	5.5	2.2	1.1	0.2
Efficacy (LPW)	59	59	59	59	59	59	59

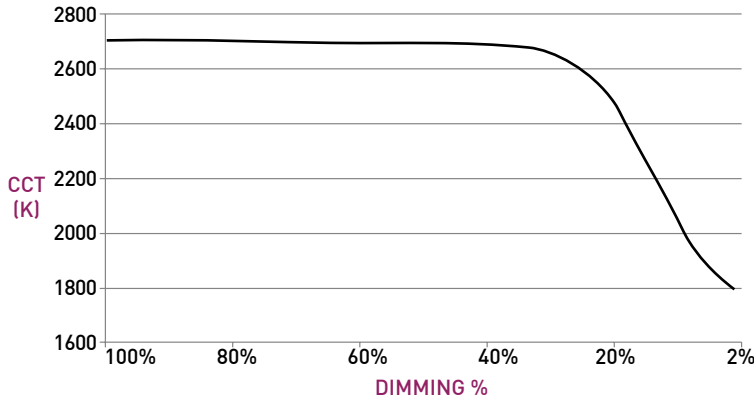

HALOGEN PROFILE

90L11AWD 3000K - 1800K	Full on 100%	Dimmed to 80%	Dimmed to 70%	Dimmed to 50%	Dimmed to 20%	Dimmed to 10%	Dimmed to 2%
CCT (K)	3000	3000	3000	3000	2500	1900	1800
Light Output (Lm)	679	543	475	340	136	68	14
Power (W)	11	8.8	7.7	5.5	2.2	1.1	0.2
Efficacy (LPW)	62	62	62	62	62	62	62

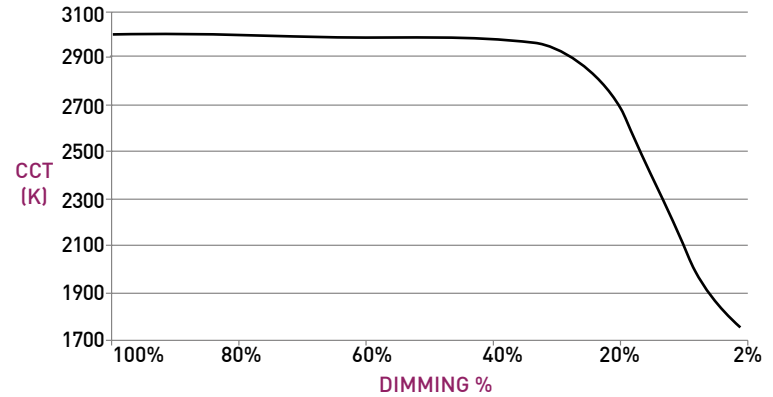

NOTE: LIN-TO-LIN 0-10V PAIRING NOT COMPATIBLE WITH WARM DIM.

TRACK HEAD MONOPOINT INSPIRED CTM1 WALLWASH

TRACK HEAD

- A ADJUSTABILITY**
Up to 90° lockable tilt and 370° lockable rotation.
- B TRACK ADAPTER**
Proprietary asymmetric track adapter; compatible with Lucifer Lighting track only. Available in Black and White finishes to match track systems.
- C STEM**
Standard length is 1.4", available in even-inch increments from 2" - 8". Stem is not field cuttable. Powdercoat finishes standard, consult factory for Alumina finishes.
- D BODY**
Power supply integrated into fixture body. Available in powdercoat and Alumina finishes. Body interior **D1** matches exterior finish; interior and exterior finishes cannot be specified differently.
- E OPTIC**
Proprietary optic for optimal wallwashing.
- F MEDIA**
Asymmetrical spread lens, included and sealed in place.
- G BAFFLE**
Baffle minimizes aperture glare and conceals view into fixture. Available in black powdercoat finish.
- H KICK REFLECTOR**
Miro® Kick reflector uniformly spreads light projected to wall plane. Kick reflector not available with painted or Alumina finishes.

DIMENSIONS / DRAWINGS

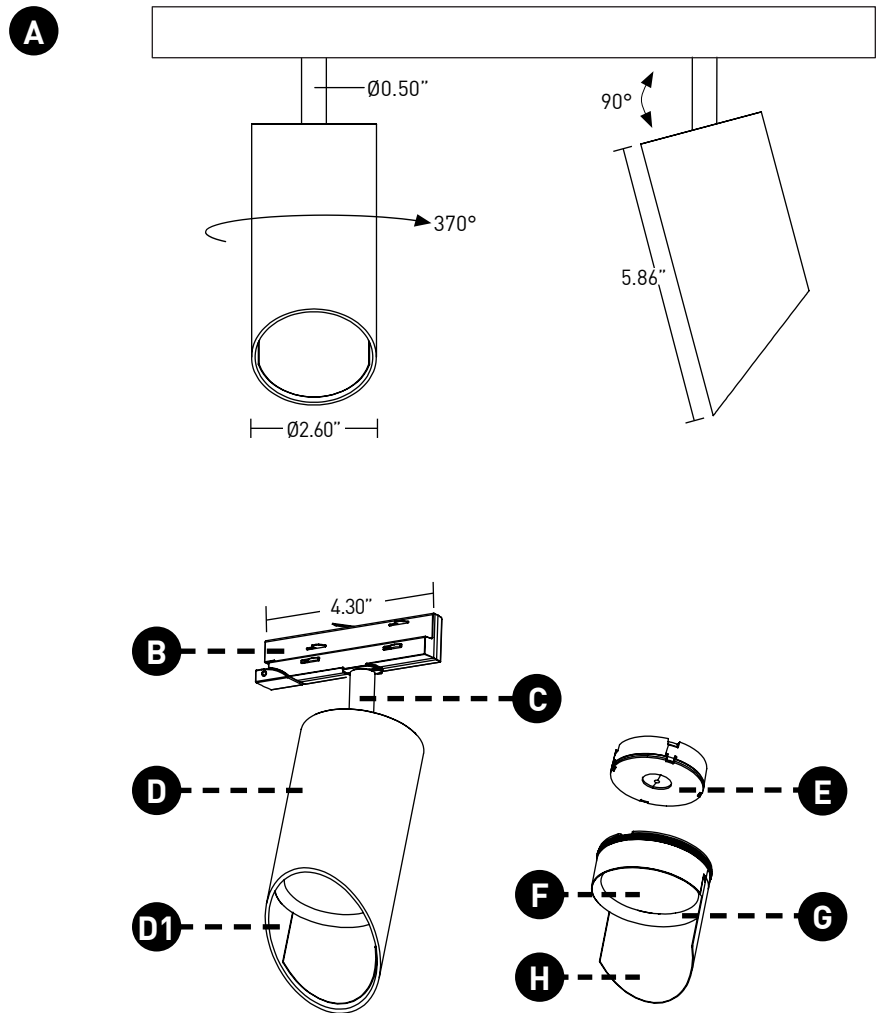

TRACK HEAD MONOPOINT INSPIRED CTM1 WALLWASH

TECHNICAL

CONSTRUCTION

Track Head: Machined aluminum body; painted finishes are granulated powder coat; Alumina finishes are anodized aluminum.

STATIC WHITE LED

2-step MacAdam ellipse LED module available in 80+, 90+ and 97+ CRI configurations in color temperatures of 2700K, 3000K, 3500K and 4000K. 3-step MacAdam ellipse LED module available in 90+ CRI configuration in color temperature of 2400K. Average rated lamp life of 50,000 hours.

WARM DIM LED

3-step MacAdam ellipse warm dim LED module available in 90+ CRI configuration. 2900K or 2600K at full brightness, warming to 1800K at full dim. Average rated lamp life of 50,000 hours.

POWER SUPPLY PERFORMANCE AND DIMMING INFORMATION

Power Supply	CE3
Minimum °C	-20 °C
Maximum °C	40 °C
Dimming %	3.0%

MOUNTING

Cylinder track head mounts to Lucifer Lighting Company recessed, surface or pendant mount track assemblies, specified separately.

SPACING AND TILT

Trackhead must be tilted to achieve wallwashing effect. Recommended fixture spacing is 36" on center with 36" setback from wall plane with 15° tilt.

LISTING

Listed to UL1574 standard for Dry locations. JA8-2022 Title 24 listed. NEMA 410 compliant.

DECLARE

LBC Red List Approved.

LIMITED WARRANTY

Manufacturer's Limited Warranty guarantees product(s) listed to be free from defects in material and workmanship under normal use and service for 1-year. LED and power supplies are warranted to operate with 70% of original flux and remain within a range of 3 duv for a period of 5-years. Warranty period begins from the date of shipment by Seller. [Consult website for full warranty terms and conditions.](#)

CHANGE LOG

- 1.03/16/2023: REMOVED ALL STEM LENGTH OFFERINGS EXCEPT STANDARD 1.4" LENGTH.
- 2.05/12/2023: ADDED LBC RED LIST APPROVED.
- 3.08/08/2023: ADDED NEW LED AND OPTIC SYSTEM.
- 4.02/08/2024: ADDED 2400K AND WARM DIM OFFERINGS.
- 5.09/30/2024: ADDED ADDITIONAL STEM LENGTHS UP TO 8" MAX.
- 6.11/14/2024: ADDED ADDITIONAL POWDERCOAT FINISHES.
- 7.05/07/2025: UPDATED WARM DIM OFFERING.